

SHARP

Important

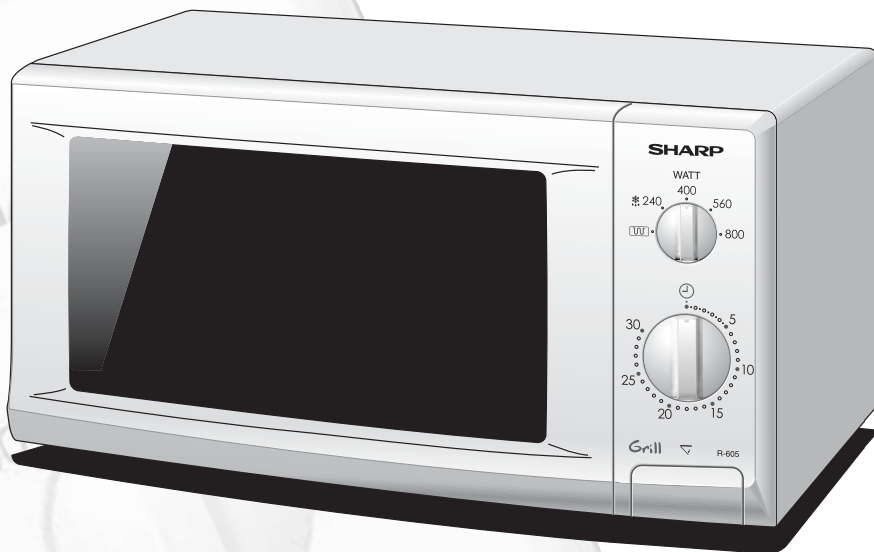

R-605 MICROWAVE OVEN WITH GRILL OPERATION MANUAL WITH COOKBOOK

OPERATION MANUAL

This operation manual contains important information which you should read carefully before using your microwave oven.

IMPORTANT: There may be a serious risk to health if this operation manual is not followed or if the oven is modified so that it operates with the door open.

800 W (IEC 60705)

ENGLISH

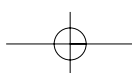
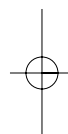
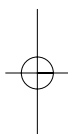
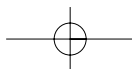



CONTENTS



OVEN AND ACCESSORIES	2
CONTROL PANEL	3
IMPORTANT SAFETY INSTRUCTIONS	4-6
INSTALLATION	6
MICROWAVE POWER LEVELS	6
MICROWAVE/GRILL COOKING	7
CARE AND CLEANING	8
SERVICE CALL CHECK	8
COOKBOOK	9-19
SERVICE ADDRESSES	20-25
SPECIFICATIONS	26

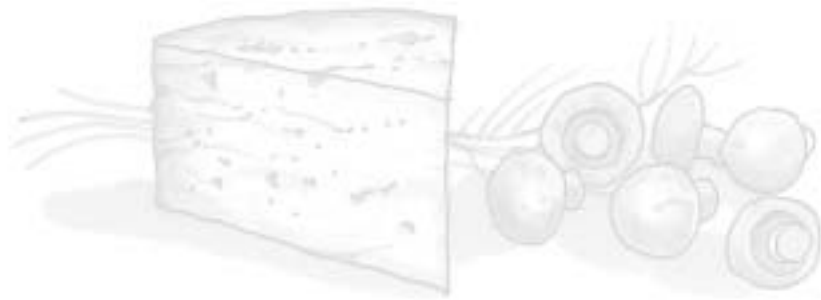
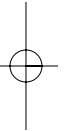
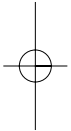

ENGLISH

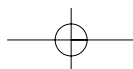

OVEN AND ACCESSORIES

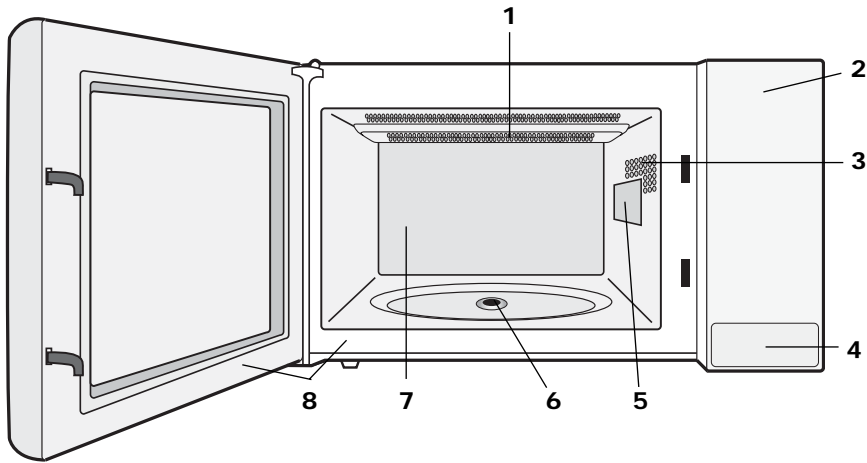

1. Grill heating element
2. Control Panel
3. Oven Lamp
4. Door opening button
5. Waveguide cover
6. Seal packing
7. Oven cavity
8. Door seals and sealing surfaces

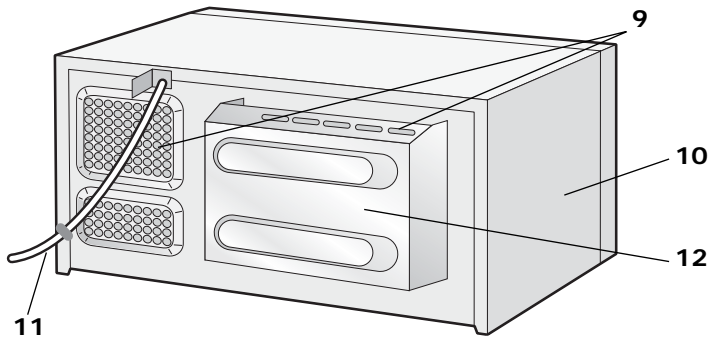

ACCESSORIES:

Check to make sure the following accessories are provided:

13. Turntable
 14. Roller stay
 15. Seal packing
 16. Rack
- Place the roller stay over the seal packing on the floor of the cavity.
 - Then place the turntable on to the roller stay.
 - To avoid turntable damage, ensure dishes or containers are lifted clear of the turntable rim when removing them from the oven.

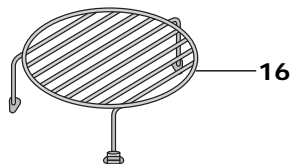
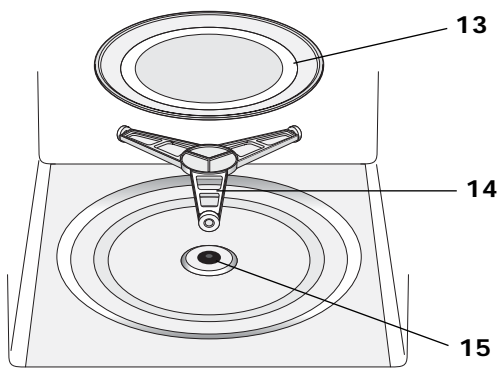

NOTE: When you order accessories, please mention two items: part name and model name to your dealer or SHARP authorised service agent.

CONTROL PANEL

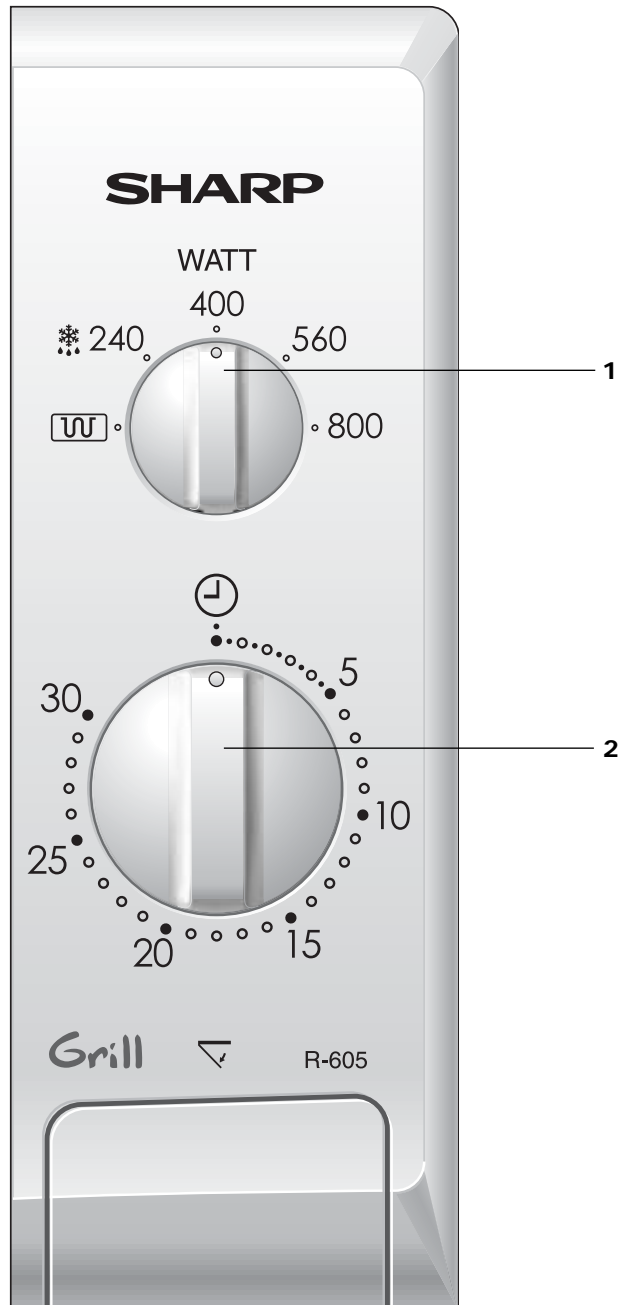

1. MICROWAVE POWER/GRILL CONTROL knob
2. TIMER knob (0 - 30 Min.)

ENGLISH



IMPORTANT SAFETY INSTRUCTIONS

IMPORTANT SAFETY INSTRUCTIONS: READ CAREFULLY AND KEEP FOR FUTURE REFERENCE

To avoid the danger of fire

The microwave oven should not be left unattended during operation. Power levels that are too high or cooking times that are too long may overheat foods resulting in a fire.

This oven is not designed to be built in to a kitchen unit.

The electrical outlet must be readily accessible so that the unit can be unplugged easily in an emergency.

The AC power supply must be 230V, 50Hz, with a minimum 10 A distribution line fuse, or a minimum 10 A distribution circuit breaker.

It is recommended that a separate circuit serving only this appliance be provided.

Do not place the oven in areas where heat is generated. For example, close to a conventional oven.

Do not install the oven in an area of high humidity or where moisture may collect.

Do not store or use the oven outdoors.

If food being heated begins to smoke, DO NOT OPEN THE DOOR. Turn off and unplug the oven and wait until the food has stopped smoking. Opening the door while food is smoking may cause a fire.

Use only microwave-safe containers and utensils. See Page XX.

Do not leave the oven unattended when using disposable plastic, paper or other combustible food containers.

Clean the waveguide cover, the oven cavity, the turntable and roller stay after use. These must be dry and free from grease. Built-up grease may overheat and begin to smoke or catch fire.

Do not place flammable materials near the oven or ventilation openings. Do not block the ventilation openings.

Remove all metallic seals, wire twists, etc., from food and food packages. Arcing on metallic surfaces may cause a fire.

Do not use the microwave oven to heat oil for deep frying. The temperature cannot be controlled and the oil may catch fire.

To make popcorn, use only special microwave popcorn makers.

Do not store food or any other items inside the oven.

Check the settings after you start the oven to ensure the oven is operating as desired.

See the corresponding hints in this operation manual and the cookery book section.

To avoid the possibility of injury

WARNING:

Do not operate the oven if it is damaged or malfunctioning. Check the following before use:

- The door; make sure the door closes properly and ensure it is not misaligned or warped.
- The hinges and safety door latches; check to make sure they are not broken or loose.
- The door seals and sealing surfaces; ensure that they have not been damaged.
- Inside the oven cavity or on the door; make sure there are no dents.
- The power supply cord and plug; ensure that they are not damaged.

Never adjust, repair or modify the oven yourself. It is hazardous for anyone other than a competent person to carry out any service or repair operation which involves the removal of a cover which gives protection against exposure to microwave energy.

Do not operate the oven with the door open or alter the door safety latches in any way.

Do not operate the oven if there is an object between the door seals and sealing surfaces.

Do not allow grease or dirt to build up on the door seals and adjacent parts. Follow instructions for "Care and Cleaning", Page 8.

Individuals with PACEMAKERS should check with their doctor or the manufacturer of the pacemaker for precautions regarding microwave ovens.

To avoid the possibility of electric shock

Under no circumstances should you remove the outer cabinet.

Never spill or insert any objects into the door lock openings or ventilation openings. In the event of a spill, turn off and unplug the oven immediately, and call an authorised SHARP service agent.

Do not immerse the power supply cord or plug in water or any other liquid.

Do not let the power supply cord hang over the edge of a table or work surface.

Keep the power supply cord away from heated surfaces, including the rear of the oven.

Do not attempt to replace the oven lamp yourself or allow anyone who is not an electrician authorised by SHARP to do so. If the oven lamp fails, please consult your dealer or an authorised SHARP service agent.

If the power supply cord of this appliance is damaged, it must be replaced by an authorised SHARP service agent.

IMPORTANT SAFETY INSTRUCTIONS



To avoid the possibility of explosion and sudden boiling:

WARNING: Liquids and other foods must not be heated in sealed containers since they are liable to explode.

Never use sealed containers. Remove seals and lids before use. Sealed containers can explode due to a build up of pressure even after the oven has been turned off.

Take care when microwaving liquids. Use a wide-mouthed container to allow bubbles to escape.

Never heat liquids in narrow necked containers such as baby bottles, as this may result in the contents erupting from the container when heated and cause burns.

To prevent sudden eruption of boiling liquid and possible scalding:

1. Stir liquid prior to heating/reheating.
2. It is advisable to insert a glass rod or similar utensil into the liquid whilst reheating.
3. Let liquid stand for at least 20 seconds in the oven at the end of cooking time to prevent delayed eruptive boiling.

Do not cook eggs in their shells, and whole hard boiled eggs should not be heated in microwave ovens since they may explode even after microwave cooking has ended. To cook or reheat eggs which have not been scrambled or mixed, pierce the yolks and the whites, or the eggs may explode. Shell and slice hard boiled eggs before reheating them in the microwave oven.

Pierce the skin of such foods as potatoes, sausages and fruit before cooking, or they may explode.

To avoid the possibility of burns

Use pot holders or oven gloves when removing food from the oven to prevent burns.

Always open containers, popcorn makers, oven cooking bags, etc., away from the face and hands to avoid steam burns.

To avoid burns, always test food temperature and stir before serving and pay special attention to the temperature of food and drink given to babies, children or the elderly.

Temperature of the container is not a true indication of the temperature of the food or drink; always check the food temperature.

Always stand back from the oven door when opening to avoid burns from escaping steam and heat.

Slice stuffed baked foods after heating to release steam and avoid burns.

Keep children away from the door to prevent them burning themselves.

Do not touch the oven door, outer cabinet, rear cabinet, oven cavity, ventilation openings, accessories and dishes during **GRILL** mode operation as they will become hot. Before cleaning make sure they are not hot.

To avoid misuse by children

WARNING: Only allow children to use the oven without supervision when adequate instructions have been given so that the child is able to use the oven in a safe way and understands the hazards of improper use.

Do not lean or swing on the oven door. Do not play with the oven or use it as a toy.

Children should be taught all important safety instructions: use of pot holders, careful removal of food coverings; paying special attention to packaging (e.g. self-heating materials) designed to make food crisp, as they may be extra hot.

Other warnings

Never modify the oven in any way.

Do not move the oven while it is in operation.

This oven is for home food preparation only and may only be used for cooking food. It is not suitable for commercial or laboratory use.

To promote trouble-free use of your oven and avoid damage.

Never operate the oven when it is empty except where recommended in the operation manual, see Page 7. Doing so may damage the oven.

When using a browning dish or self-heating material, always place a heat-resistant insulator such as a porcelain plate under it to prevent damage to the turntable and roller stay due to heat stress. The preheating time specified in the dish's instructions must not be exceeded.

Do not use metal utensils, which reflect microwaves and may cause electrical arcing. Do not put cans in the oven.

Use only the turntable and the roller stay designed for this oven.

To prevent the turntable from breaking:

- (a) Before cleaning the turntable with water, leave the turntable to cool.
- (b) Do not put hot foods or hot utensils on a cold turntable.
- (c) Do not put cold foods or cold utensils on a hot turntable.

Do not place anything on the outer cabinet during operation.

Do not use plastic containers for microwaving if the oven is still hot from using the **GRILL** mode operation, because they may melt. Plastic containers must not be used during above modes unless the container manufacturer says they are suitable.



MICROWAVE/GRILL COOKING

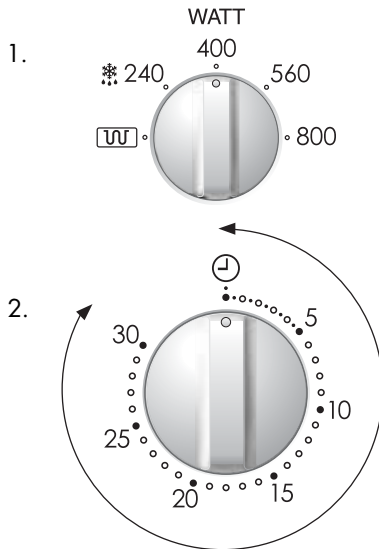

1. Set the **MICROWAVE POWER/GRILL CONTROL** knob to the desired setting, microwave or grill.

2. Set the **TIMER** knob to the desired cooking time.
The oven starts cooking.

* When cooking has finished, the **TIMER** knob will return to "●" (off), the signal will sound, and the oven and oven lamp will turn off automatically.

COOKING HINTS:

In the cookbook section, you will find detailed instructions for recipe preparation, only basic cooking hints are given here.

1. Push the door opening button and the door will open, then place the food on the turntable.
2. Whenever setting the **TIMER** to less than 2 minutes, turn the **TIMER** knob past the 5 minute mark, and then back to the desired setting.
3. If you wish to stop cooking before the cooking time has elapsed, turn the **TIMER** knob back to "●" (off), or open the oven door. The oven door may be opened at any time during cooking. To continue cooking, close the door. If you wish to change the cooking time during cooking, simply turn the **TIMER** knob to the desired new setting.

WARNING: Be sure to turn the **TIMER** knob back to "●" (off) position when the oven is not in use, or the oven will start when the oven door is closed.

HEATING WITHOUT FOOD

You may detect smoke or a burning smell when using the grill for the first time, this is normal and not a sign that the oven is out of order.

To avoid this problem, when first using the oven operate the grill without food for 20 minutes.

IMPORTANT: During grill operation, to allow smoke or smells to disperse, open a window or switch the kitchen ventilation on.

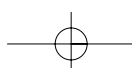



CARE AND CLEANING

CAUTION: DO NOT USE COMMERCIAL OVEN CLEANERS, ABRASIVE, HARSH CLEANERS OR SCOURING PADS ON ANY PART OF YOUR MICROWAVE OVEN.

Oven exterior

The outside of your oven can be cleaned easily with mild soap and water. Make sure the soap is wiped off with a moist cloth, and dry the exterior with a soft towel.

Oven controls

Open the door before cleaning to de-activate the oven controls. Care should be taken when cleaning the oven controls. Using a cloth dampened with water only, gently wipe the panel until it becomes clean. Avoid using excessive amounts of water.

Do not use any sort of chemical or abrasive cleaner.

CAUTION:

Take care not to move the **TIMER** knob from "●" (off) position during cleaning, or the oven will start as soon as you close the door.

Oven Interior

1. For cleaning, wipe any splatters or spills with a soft damp cloth or sponge after each use while the oven is still warm. For heavier spills, use a mild

soap and wipe several times with a damp cloth until all residues are removed. Do not remove the waveguide cover.

2. Make sure that mild soap or water does not penetrate the small vents in the walls which may cause damage to the oven.
3. Do not use spray type cleaners on the oven interior.
4. At regular intervals, heat the grill, see page 7, because the splashed dirt or oil around the grill heating element and oven walls may cause smoke and odour

Turntable and Roller stay

Remove the turntable and roller stay from the oven. Wash the turntable and roller stay in mild soapy water. Dry with a soft cloth. Both the turntable and the roller stay are dishwasher safe.

Rack

The rack should be washed in mild washing up liquid solution and dried. The rack is dishwasher safe.

Door

To remove all trace of dirt, regularly clean both sides of the door, the door seals and sealing surfaces with a soft, damp cloth.



SERVICE CALL CHECK

Please check the following before calling for service.

1. Power Supply

Check the power plug is properly connected to a suitable wall outlet.

Check the line fuse/circuit breaker is functioning properly.

2. Place a cup of water (approx. 150 ml) in the oven and close the door securely.

Programme the oven for one minute on 800 W power and start the oven.

Does the oven lamp come on?

YES _____ NO _____

Does the turntable rotate?

YES _____ NO _____

NOTE: The turntable turns in either direction.

Does the ventilation work?

YES _____ NO _____

(Place your hand over the ventilation openings and check for air flow.)

After 1 minute does the signal sound?

YES _____ NO _____

Is the water warm after the above operation?

YES _____ NO _____

3. Set the **MICROWAVE POWER/GRILL CONTROL** knob to **GRILL**

cooking for 3 minutes.

After 3 minutes does the GRILL heating element become red?

YES _____ NO _____

If you answer "No" to any of the above questions, call a Service Technician appointed by SHARP and report the results of your check. See inside back cover for details of address.

NOTE: If you cook the food over the standard time with the same cooking mode, the power of the oven will lower automatically to avoid overheating. (The microwave power level will be reduced).

Cooking Mode	Standard time
Microwave 800 W	20 minutes

WHAT ARE MICROWAVES?



Microwaves are generated in the microwave oven by a magnetron and cause the water molecules in the food to oscillate.

Heat is generated by the friction which is caused, with the result that the food is thawed, heated or cooked.

SUITABLE OVENWARE



GLASS AND CERAMIC GLASS

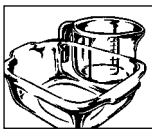

Heat-resistant glass utensils are very suitable. The cooking process can be observed from all sides. They must not, however, contain any metal (e.g. lead crystal), nor have a metallic overlay (e.g. gold edge, cobalt blue finish).

CERAMICS

Generally very suitable. Ceramics must be glazed, since with unglazed ceramics moisture can get into the ceramic. Moisture causes the material to heat up and may make it shatter. If you are not certain whether your utensil is suitable for the microwave, carry out the utensil suitability test.

PORCELAIN

Very suitable. Ensure that the porcelain does not have a gold or silver overlay and that it does not contain any metal.

PLASTIC AND PAPER UTENSILS

Heat resistant plastic utensils which are suitable for use in the microwave can be used to thaw, heat and cook food. Follow the manufacturer's recommendations.

Heat-resistant paper made for use in a microwave oven is also suitable. Follow the manufacturer's recommendations.

MICROWAVE FOIL

This, or heat-resistant foil, is very suitable for covering or wrapping. Please follow the manufacturer's recommendations.

ROASTING BAGS

Can be used in a microwave oven. Metal clips are not suitable for fastening them since the roasting bag foil might melt. Fasten the roasting bag with string and pierce it several times with a fork. Non heat-resistant food wraps are not recommended for use in a microwave oven.

BROWNING DISH

A special microwave dish made from ceramic glass with a metal alloy base, which allows food to be browned.

When using the browning dish a suitable insulator, e.g. a porcelain plate, must be placed between the turntable and the browning dish. Be careful to adhere exactly to the pre-heating time given in the manufacturer's instructions. Excessive pre-heating can damage the turntable and the turntable stand or can trigger the safety-device which will switch off the oven.

METAL

Generally speaking, metal should not be used, since microwaves do not pass through metal and therefore cannot reach the food. There are, however, exceptions: small strips of aluminium foil may be used to cover certain parts of the food, so that these do not thaw too quickly or begin to cook (e.g. chicken wings). Small metal skewers and aluminium containers (e.g. of ready-cooked meals) can be used. They must, however, be small in relation to the food, e.g. aluminium containers must be at least $\frac{2}{3}$ to $\frac{3}{4}$ filled with food. It is recommended that you transfer the food into a dish suitable for use in the microwave. When using aluminium containers or other metal utensils there must be a gap of approx. 2 cms between them and the walls of the cooking area, otherwise the walls could be damaged by possible arcing.

NO UTENSIL SHOULD HAVE A METAL OVERLAY metal parts such as screws, bands or handles.

UTENSIL SUITABILITY TEST

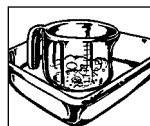

If you are not sure whether your utensil is suitable for use in your microwave oven, carry out the following test: Place the utensil into the oven. Place a glass container filled with 150 ml of water on or next to the utensil. Switch on the oven at 800 W power for 1 to 2 minutes. If the utensil stays cool or just warm to the touch, it is suitable. Do not use this test on a plastic utensil. It could melt.



TIPS AND ADVICE

TIME SETTINGS

In general the thawing, heating and cooking times are significantly shorter than when using a conventional oven. For this reason you should adhere to the recommended times given in this cookery book. It is better to set the times too short, rather than too long. Test the food after it has been cooked. It is better to have to cook something for a little longer than to overcook it.

INITIAL TEMPERATURES

Thawing, heating and cooking times are dependent upon the initial temperature of the food. Deep-frozen food and food stored in a refrigerator, for example, requires longer than food which has been stored at room temperature. For heating and cooking, normal storage temperatures are assumed (refrigerator temperature approx. 5° C, room temperature approx. 20° C). For thawing the temperature of the deep freeze is assumed to be -18° C.

COOKING TIMES

All the times given in this cookery book are guidelines, which can be varied according to the initial temperature, weight and condition of the food (water or fat content etc.).

SALT, SPICES AND HERBS

Food cooked in your microwave retains its individual flavour better than it does when conventional preparation methods are used. For this reason you should use salt sparingly and normally add it only after cooking. Salt absorbs liquid and dries out the outer layer of food. Herbs and spices can be used as normal.

ADDITION OF WATER

Vegetables and other foods with a high water content can be cooked in their own juice or with the addition of a little water. This ensures that many vitamins and minerals are preserved.

FOOD IN SKINS OR SHELLS

Foods such as sausages, chickens, chicken legs, baked potatoes, tomatoes, apples, egg yolks or such like should be pricked or pierced with a fork or small wooden skewer. This will enable the steam which forms to dissipate without splitting the skin or shell.

FATTY FOODS

Fatty meat and layers of fat cook better than lean portions of meat. Before cooking, cover the fatty portions with a piece of aluminium foil or place the food with the fat side down.

LARGE AND SMALL QUANTITIES

Microwave times are directly dependent upon the amount of food which you would like to thaw, heat or cook. This means that small portions cook more quickly than larger ones. As a rule of thumb:

TWICE THE AMOUNT = ALMOST TWICE THE TIME
HALF THE AMOUNT = HALF THE TIME

DEEP AND SHALLOW CONTAINERS

Both containers have the same capacity, but the cooking time is longer for the deeper one. You should therefore choose as flat a container as possible with a large surface area. Only use deep containers for dishes where there is a danger of overcooking, e.g. for noodles, rice, milk etc..

ROUND AND OVAL CONTAINERS

Food cooks more evenly in round or oval containers than in containers with corners, since the microwave energy concentrates in the corners and the food in these areas could become overcooked.

COVERING

Covering the food retains the moisture within it and shortens the cooking time. Use a lid, microwave foil or a cover. Foods which are to be crispy, e.g. roasts or chickens, should not be covered. As a general rule, whatever would be covered in a conventional oven should also be covered in a microwave oven. Whatever would be uncovered in an ordinary oven can also be left uncovered in a microwave oven.

IRREGULAR SHAPED FOOD

Place the thicker, more compacted end of the food pointing towards the outside. Place vegetables (such as broccoli) with the stalks pointing outward.

STIRRING

Stirring the food is necessary, since the microwaves begin by heating the outer areas. The temperature is thereby equalised and the food heats up evenly.

ARRANGEMENT OF FOOD

Place a number of individual portions, such as small pudding moulds, cups or potatoes in their jackets, in a circle on the turntable. Keep the portions at a distance from each other so that the microwave energy can reach the food from all sides.

TIPS AND ADVICE

**TURNING**

Medium-sized items, such as hamburgers and steaks, should be turned over once during cooking, in order to shorten the cooking process. Large items, such as roasts and chickens, must be turned, since the upper side receives more microwave energy and could dry out if not turned.

STANDING TIME

Keeping to the standing time is one of the most important rules with microwaves. Almost all foods, which are thawed, heated or cooked in the microwave, require a certain amount of time to stand,

during which temperature equalisation takes place and the moisture in the food is evenly distributed.

BROWNING AGENTS

After more than 15 minutes' cooking time food acquires a brownness, although this is not comparable to the deep brownness and crispness obtained through conventional cooking. In order to obtain an appetising brown colour you can use browning agents. For the most part they simultaneously act as seasoning agents. In the following table you will find some suggestions for substances you might use for browning and some of the uses to which you might put them.

BROWNING AGENT	DISH	METHOD
Melted butter and dried paprika	Poultry	Coat the poultry with the butter/paprika mixture
Dried paprika	Oven baked dishes "Cheese toasties"	Dust with paprika
Soya sauce	Meat and poultry	Coat with the sauce
Barbecue and Worcestershire sauce, Gravy	Roasts, Rissoles, Small roasted items	Coat with the sauce
Rendered down bacon fat or dried onions	Oven baked dishes, toasted items, soups, stews	Sprinkle pieces of bacon or dried onions on top
Cocoa, chocolate flakes, brown icing, honey and marmalade	Cakes and desserts	Sprinkle pieces on top of cakes and desserts or use to glaze

HEATING

- Ready-prepared meals in aluminium containers should be removed from the aluminium container and heated on a plate or in a dish.
- Remove the lids from firmly closed containers.
- Food should be covered with microwave foil, a plate or cover (obtainable from stores), so that the surface does not dry out. Drinks need not be covered.
- When boiling liquids such as water, coffee, tea or milk, place a glass stirrer in the container.
- If possible, stir large quantities from time to time, to ensure that the temperature is evenly distributed.
- The times are for food at a room temperature of 20° C. The heating time for food stored in a refrigerator should be increased slightly.
- After heating allow the food to stand for 1-2 minutes, so that the temperature inside the food can be evenly distributed (standing time).
- The times given are guidelines which can be varied according to the initial temperature, weight, water content, fat content or the result which you wish to achieve.

DEFROSTING

Your microwave is ideal for thawing. Thawing times are usually considerably shorter than in traditional methods. Here are a few tips. Take the frozen item out of its packaging and place on a plate for thawing.

Boxes and Containers

Boxes and containers suitable for microwaves are particularly good for thawing and heating food, since they can withstand temperatures in a deep freeze (down to approx. -40° C) as well as being heat-resistant (up to approx. 220° C). You can therefore use the same container to freeze, thaw, heat and even cook the food, without having to transfer it.

Covering

Cover thin parts with small strips of aluminium foil before thawing. Thawed or warm parts should likewise be covered with aluminium strips during thawing. This stops the thin parts becoming too hot while thicker parts are still frozen.

Correct setting

It is better to choose a setting which is too low rather than one which is too high. By so doing you will ensure that the food thaws evenly. If the microwave setting is too high, the surface of the food will already have begun to cook while the inside is still frozen.



TIPS AND ADVICE

Turning/stirring

Almost all foods have to be turned or stirred from time to time. As early as possible, separate parts which are stuck together and rearrange them.

Small amounts

Thaw more quickly and evenly than larger ones. We recommend that you freeze portions which are as small as possible. By so doing you will be able to prepare whole menus quickly and easily.

Foods requiring careful handling

Foods such as gateaux, cream, cheese and bread should only be partially thawed and then left to thaw completely at room temperature. By so doing you will avoid the outer areas becoming too hot while the inside is still frozen.

Standing time

This is particularly important after thawing food, as the thawing process continues during this period. In the thawing table you will find the standing times for various foods. Thick, dense foods require a longer standing time than thinner foods or food of a porous nature. If the food has not thawed sufficiently, you may continue thawing it in the microwave oven or lengthen the standing time accordingly. At the end of the standing time you should process the food as soon as possible and not re-freeze it.

COOKING FRESH VEGETABLES

- When buying vegetables try to ensure that, as far as possible, they are of similar size. This is particularly important when you want to cook the vegetables whole (e.g. boiled potatoes).
- Wash the vegetables before preparing them, clean them and only then weigh the required quantity for the recipe and chop them up.
- Season them as you would normally, but as a rule only add salt after cooking.
- Add about 5 tbsps of water for 500 g of vegetables. Vegetables which are high in fibre require a little more water. You will find information about this in the table.
- Vegetables are usually cooked in a dish with a lid. Those with a high moisture content, e.g. onions or boiled potatoes, can be cooked in microwave foil without adding water.
- After half the cooking time has elapsed vegetables should be stirred or turned over.

- After cooking allow the vegetables to stand for approx. 2 minutes, so that the temperature disperses evenly (standing time).

- The cooking times given are guidelines and depend upon the weight, initial temperature and condition of the type of vegetable in question. The fresher the vegetables, the shorter the cooking times.

COOKING MEAT, FISH AND POULTRY

- When buying food items, try to ensure that, as far as possible, they are of similar size. This will ensure that they are cooked properly.
- Before preparation wash meat, fish and poultry thoroughly under cold running water and pat them dry with kitchen paper. Then continue as normal.
- Beef should be well hung and have little gristle.
- Even though the pieces may be of a similar size, cooking results may vary. This is due, amongst other things, to the kind of food, variations in the fat and moisture content as well as the temperature before cooking.
- After the food has been cooking for 15 minutes it acquires a natural brownness, which may be enhanced by the use of a browning agent. If, in addition, you would like the surface to be crisp you should either use the browning dish or sear the food on your cooker and finish cooking it in your microwave. By doing this you will simultaneously obtain a brown base for making a sauce.
- Turn large pieces of meat, fish or poultry half way through the cooking time, so that they are cooked evenly from all sides.
- After cooking cover roasts with aluminium foil and allow them to stand for approx. 10 minutes (standing time). During this period the roast carries on cooking and the liquid is evenly distributed, so that when it is carved a minimum amount of juice is lost.

DEFROSTING AND COOKING

Deep-frozen dishes can be thawed and cooked at the same time in one process in your microwave. You will find some examples in the table. Do take note, however, of the general advice given on "heating" and "thawing" food. Please refer to the manufacturer's instructions on the packaging when preparing deep-frozen dishes. These usually contain precise cooking times and offer advice on preparation.

TABLES



ABBREVIATIONS USED

tbsp = tablespoon
 tsp = teaspoon
 l.p. = large pinch
 s.p. = small pinch
 Cup = cupful
 Sach. = sachet

kg = kilogram
 g = gram
 l = litre
 ml = millilitre
 cm = centimetre
 DFC = dry fat content

DF = deep frozen
 MW = microwave
 MWO = microwave oven
 min = minutes
 sec = seconds
 dm = diameter
 ca = circa

The recommended times are average and may need to be changed according to the, shape, composition, weight and temperature (i.e. frozen, refrigerated or at room temperature) of the food.

TABLE: HEATING FOOD AND DRINK

Food / Drink	Quantity -g/ml-	Watt	Time -Min-	Hints
Drinks, 1 cup	150	800 W	ca. 1	do not cover
Platters (Vegetables, meat and trimmings)	400	800 W	3-6	sprinkle some water onto the sauce, cover stir half way through the heating time
Stew, Soup	200	800 W	2-3	cover, stir after heating
Garnishes	200	800 W	1-3	sprinkle some water on them, cover stir from time to time
Meat, 1 slice ¹	200	800 W	3-4	thinly spread some sauce on it, cover
2 Sausages	180	400 W	2-2 ¹ / ₂	pierce the skin several times
Baby food, 1 glass	190	400 W	ca. 1	remove the lid, after heating stir well and test the temperature
Melting butter or margarine ¹	50	800 W	¹ / ₂ -1	
Melting chocolate	100	400 W	2-3	stir from time to time
Dissolving six sheets of gelatin	10	400 W	¹ / ₂	dip into water, squeeze thoroughly and place in a soup bowl, stir from time to time

¹ From refrigerator temperature

TABLE: DEFROSTING AND COOKING

Food (frozen)	Quantity -g-	Watt	Cooking time -Min-	Added water -tbsps/ml-	Hints	Standing time -Min-
Fish fillet	300	800 W	10-11	-	cover	1-2
Plated meal	400	800 W	8-10	-	cover, turn after 6 minutes	2
Frozen vegetables e.g. Spinach, broccoli, Peas	300	800 W	7-9	3-5tbsps	cover, stir once or twice during cooking	2
Frozen mixed veg.	500	800 W	12-14	3-5tbsps	cover, stir halfway through cooking time	2
Fresh vegetables, (e.g. Potatoes, peas, leek, carrots)	500	800 W	9-11	5 tbsps	Prepare in the common way, cover and stir halfway through cooking	2
	300	800 W	6-8	3 tbsps	Prepare in the common way, cover and stir halfway through cooking	2



TABLES

TABLE: DEFROSTING

Food	Quantity -g-	Watt	Defrosting time -Min-	Hints	Standing time -Min-
Roast meat (e.g. pork, beef, lamb, veal)	500	80 W	10-14	place on an upturned plate, during cooking turn 1-2 times	30
Steaks, Pork chops, Goulash, Chicken legs	200	240 W	4-5	turn halfway through defrosting time	10-15
Sausages	300	240 W	4-5	place next to each other, turn halfway through defrosting time	5-10
Duck, turkey	1500	80 W	48-52	place upon an upturned plate, during cooking turn over 1-2 times	30-90
Chicken	1200	80 W	39-43	place upon an upturned plate, during cooking turn over 1-2 times	30-90
Whole fish	800	240 W	9-12	turn halfway through defrosting time	10-15
Fish fillet	400	240 W	7-10	turn halfway through defrosting time	5-10
Crab	300	240 W	6-8	turn halfway through defrosting time	5
Rolls, 2	80	240 W	ca. 1	only partially defrost	-
Bread sliced,	250	240 W	2-4	place slices next to each other, only partially defrost	5
Whole loaf	500	240 W	7-10	turn halfway through defrosting (centre still frozen)	15
Cakes, per piece	150	80 W	2-5	place on a plate	5
Whole gateau, diameter/width 25 cm		80 W	20-24	after defrosting, cut into pieces and leave space between each slice	60
Butter	250	240 W	2-4	only partially defrost	15
Fruit such as strawberries raspberries, cherries, plums	250	240 W	4-5	spread them out evenly turn halfway through defrosting time	5

The times given in the table are average and may require adjustment depending on the frozen temperature, condition and weight of food.

TABLE : COOKING FRESH VEGETABLES

Vegetable	Weight -g-	Power -Level-	Time -Min-	Hints	Added Water -tbsps/ml-
Artichokes	300	800 W	6-8	remove the stalk, cover	3-4 tbsps
Leaf Spinach	300	800 W	5-7	wash, dry well, cover, stir once or twice during cooking	-
Cauliflower	800	800 W	15-17	1 whole head, cover, divide into florets	5-6 tbsps
	500	800 W	10-12	stir during cooking	4-5 tbsps
Broccoli	500	800 W	9-11	divide into florets, cover, stir occasionally during cooking	4-5 tbsps
Mushrooms	500	800 W	8-10	whole heads, cover, stir occasionally during cooking	-
Chinese leaves	300	800 W	9-11	cut into strips, cover, stir occasionally during cooking	4-5 tbsps
Peas	500	800 W	9-11	cover, stir occasionally during cooking	4-5 tbsps
Fennel	500	800 W	9-11	cut into quarters, cover, stir occasionally during cooking	4-5 tbsps
Onions	250	800 W	5-7	whole, cook in microwave foil	-
Kohlrabi	500	800 W	10-12	dice, cover, stir occasionally during cooking	50 ml
Carrots	500	800 W	10-12	cut into rings, cover, stir occasionally during cooking	4-5 tbsps
Green peppers	500	800 W	9-11	cut into strips, stir once or twice during cooking	4-5 tbsps
Jacket potatoes	500	800 W	9-11	cover, stir occasionally during cooking	4-5 tbsps
Leeks	500	800 W	9-11	cut into rings, cover, stir occasionally during cooking	4-5 tbsps
Red cabbage	500	800 W	15-17	cut into strips, stir once or twice during cooking	50 ml
Brussels sprouts	500	800 W	9-11	whole sprouts, cover, stir occasionally during cooking	50 ml
Boiled potatoes (salted)	500	800 W	9-11	cut into large pieces of a similar size, add a little salt, cover, stir occasionally during cooking	150 ml
Celery	500	800 W	9-11	dice finely, cover, stir occasionally during cooking	50 ml
White cabbage	500	800 W	15-17	cut into strips, cover, stir occasionally during cooking	50 ml
Courgettes	500	800 W	9-11	slice, cover, stir occasionally during cooking	4-5 tbsps

TABLES



TABLE : COOKING, GRILLING AND GRATIN DISH

Food	Weight -g-	Setting	Power -Level-	Time -Min-	Hints	Standing Time -Min-
Roast meat (Pork, Lamb & Veal)	500	☼	800 W	7-8	Season to taste, place in a gratin dish and then on the turntable, after * turn over	10
		☼		3-5*		
	1000	☼	800 W	6-8		
		☼		3-5		
		☼	800 W	15-17		
		☼		7-9*		
	1500	☼	800 W	9-11		
		☼		3-4		
		☼	800 W	19-21		
		☼	560 W	6-8		
☼			6-7*			
☼		800 W	16-18			
Roastbeef (medium)	1000	☼	560 W	10-12	Season to taste, place with the fatty side downward in a flat gratin dish, put on turntable, after * turn over	10
		☼		7-8*		
		☼	560 W	7-9		
		☼		4-5		
	1500	☼	560 W	11-13		
		☼		8-10*		
Chicken	1200	☼	800 W	12-14	Season to taste, place with the breast facing downwards in a flat gratin dish, put on the turntable, after * turn over	3
		☼		7-8*		
		☼	800 W	12-14		
		☼		4-5		
Chicken legs	200	☼	800 W	2-3	Season to taste, place the skin side downwards on the rack, after * turn over	3
		☼		5-7*		
		☼		5-7		
Gratin e.g. Soufflés		☼		3-4	Place gratin dish on the rack	10
Cheese on toast 1 piece		☼	400 W	1/2	Toast the bread, spread with butter, place 1 slice of cooked ham, a slice of pineapple and a slice of processed cheese on each slice, and grill on the rack.	1
		☼		4-5		



RECIPES

Holland

MUSHROOM SOUP

Total cooking time: approx. 9-13 minutes

Utensil: bowl with lid (capacity 2 l)

Ingredients

200 g	mushrooms, sliced
1	onion (50 g), finely chopped
300 ml	meat stock
300 ml	cream
2 ¹ / ₂ tbsp	flour (25 g)
2 ¹ / ₂ tbsp	butter or margarine (25 g)
	salt and pepper
150 g	crème fraîche

1. Place the vegetables and the stock in the bowl, cover and cook.

6-8 Min. 800 W

2. Blend all the ingredients in the mixer, add the cream.
 3. Mix the flour and butter to a dough, and smooth into the soup. Season with salt and pepper, cover and cook. Stir after cooking.
- 3-5 Min. 800 W**
4. After cooking gradually stir the *crème fraîche*

Germany

CAMEMBERT TOAST

Total cooking time: approx. 1-2 minutes

Utensil:

Ingredients

4	slices of bread for toasting (80 g)
2 tbsp	butter or margarine (20 g)
150 g	Camembert
4 tsp	Cranberry jelly (40 g)
	Cayenne pepper

1. Toast the bread and spread with butter.
2. Cut the Camembert into slices and arrange on top of the toast. Put the Cranberry jelly in the middle of the cheese and sprinkle with Cayenne pepper.

3. Place the toast on a plate and heat for
- 1-2 Min. 800 W**

Tip: You can vary this recipe according to your taste. For example, you can use fresh mushrooms and grated cheese or cooked ham, asparagus and Emmental cheese.



GRILL COOKING



Austria

ROAST CHICKEN WITH STUFFING

Total cooking time 36-42 minutes

Utensils: Quiche form, kitchen twine

Ingredients

- 1 Chicken (weighing 1 kg)
- salt
- marjoram, rosemary
- 1 stale bread roll (white bread 40 g)
- 1 bunch of parsley, chopped finely (10 g)
- pinch nutmeg
- 2 tbsps butter or margarine (20 g)
- 1 yolk of egg
- 3 tbsps butter or margarine (30 g)
- 1 tbsp paprika pepper
- salt
- 1 tsp butter or margarine to grease dish

1. Wash the chicken, dry with kitchen towel. Season with salt, rosemary and marjoram.
2. To make the stuffing, soak the bread roll for about 10 minutes in cold water, then press the water out. Mix in the salt, parsley, nutmeg, butter and the egg yolk and stuff the chicken with the mixture. Tie up the opening with ties or with butcher's twine.
3. Heat the butter
approx **1 Min.** **800 W**
Stir the paprika pepper and the salt into the butter, and drizzle the mixture over the chicken.
4. Place the chicken breast down in the greased flan dish and cook without covering.
 1. **13-15 Min.** **800 W**
 2. **5-6 Min.**
 Turn over
 3. **13-15 Min.** **800 W**
 4. **4-5 Min.**
 Allow the chicken to stand for approximately 3 minutes after cooking.

Switzerland

FILLET OF FISH WITH CHEESE SAUCE

Total cooking time 24-27 minutes

Utensils: Bowl with a lid (1 l capacity)

Flan dish (approx 25 cm diameter)

Ingredients

- 3 fillets of fish (approx. 800 g)(e.g. plaice or cod)
- 2 tbsps lemon juice
- 1 tbsp butter or margarine
- 1 onion (50 g), finely chopped
- 2 tbsps flour
- 100 ml white wine
- 1 tsp vegetable oil to grease the dish
- 100 g grated Emmental cheese
- 2 tbsps chopped parsley

1. Wash the fillets, dry with kitchen towel. Drizzle with the lemon juice. Allow to stand for about 15 minutes, then dry again and salt.
2. Spread the butter over the base of the bowl. Add the chopped onion, cover and cook.
approx. **2 Min.** **800 W**
3. Sprinkle the flour over the onions and stir. Pour the white wine over and mix.
4. Grease the flan dish and place the fillets inside. Pour the sauce over the fillets, sprinkle with cheese and cook on the turntable.
 1. **18-20 Min.** **560 W**
 2. **4-5 Min.**
 Allow the fish to stand for approximately 2 minutes after cooking. Garnish with chopped parsley and serve.



GRILL COOKING

Germany

COLOURED MEAT KEBABS

Total cooking time 20-28 minutes

Utensils: Rack

Three wooden skewers (20-25 cm long)

Ingredients

- 300 g escalope of pork
- 75 g bacon
- 1-2 onions (75 g) cut into quarters
- 3 tomatoes (250 g) cut into quarters
- 1/2 green pepper (75 g), cut into nine pieces
- 3 tbsps oil
- 4 tsps paprika
- salt
- 1 tsp Cayenne pepper
- 1 tsp Worcester sauce

1. Cut the meat and bacon into 2-3 cm cubes.
2. Thread the meat and the vegetables alternately onto the three skewers.
3. Stir the seasoning into the oil and spread over the kebabs. Place the kebabs on the rack and grill.
 1. **7-10 Min.**
 2. **3-4 Min.** **800 W**
 Turn over the kebabs
 3. **7-10 Min.**
 4. **3-4 Min.** **800 W**

Spain

STUFFED HAM

Total cooking time 19-22 minutes

Utensils: Bowl with lid (2 l capacity)

Wooden skewers

Flat oval soufflé dish with lid or cling film (approx 27 cm long)

Ingredients

- 125 g leaf spinach, with stalks removed
- 125 g Fromage frais 20 % fat content
- 40 g grated Emmental cheese
- pepper
- paprika
- 6 slices of cooked ham (300 g)
- 125 ml water
- 125 ml cream
- 2 tbsp flour (20 g)
- 2 tbsp butter or margarine (20 g)
- 1 tsp butter or margarine to grease the dish

1. Chop the spinach into small pieces, mix with the fromage frais and the cheese and season with pepper and paprika to taste.
2. Place a tablespoon of the filling on top of each slice of cooked ham, and roll up. Spear the ham with a wooden skewer to fasten it.
3. Make a béchamel sauce; to do this pour the water and cream into the bowl, cover and heat.

3-4 Min. **800 W**

 Mix the flour and butter to make a roux, add to the liquid and whisk until dissolved. Cover, bring to the boil and allow to thicken.

1 Min. **800 W**

 Stir and taste.
4. Place the sauce into the greased dish, position the filled rolls of ham onto the sauce. Cover with microwave foil.

11-13 Min. **800 W**
5. Remove the microwave foil and continue grilling on rack.

approx. **4 Min.**

 Allow the rolls of ham to stand for about 2 minutes after cooking.

Tip:

You can buy ready-made béchamel sauce and use it for this recipe.

GRILL COOKING



Spain

MUSHROOMS WITH ROSEMARY STUFFING

Total cooking time 15-22 minutes

Utensils: Bowl with lid (1 l capacity)
Flat round bowl with lid (approx
22 cm diameter)

Ingredients

8 large mushrooms (approx 225 g) whole
2 tbsps butter or margarine (20 g)
1 onion (50 g), chopped finely
50 g diced ham
black milled pepper
rubbed rosemary
125 ml dry white wine
125 ml cream
2 tbsps flour (20 g)

1. Remove the mushroom stalks and cut them up into small pieces.
2. Put the butter in the bowl and spread on the base. Add the onion, diced ham and the chopped mushroom stalks, season with the pepper and rosemary, cover and cook.

4-5 Min. ☼ 800 W

Allow to cool.

3. Place 100 ml of the wine and the cream in the round bowl. Cover and heat.

2-3 Min. ☼ 800 W

4. Blend the flour into the remainder of the wine and stir into the hot liquid. Cover and cook. Stir twice during cooking.

1-2 Min. ☼ 800 W

5. Fill the mushrooms with the ham and onion mixture and place into the sauce. Place the bowl on the rack and cook.

1. **4-6 Min. ☼ 800 W**2. **4-5 Min. ☼**

Allow the mushrooms to stand for about 2 minutes after they have cooked.

Germany

COURGETTES - NOODLES - GRATIN

Total cooking time 46-55 minutes

Utensils: Bowl with lid (2 l capacity)
Soufflé dish (approx 26 cm long)

Ingredients

500 ml water
 $\frac{1}{2}$ tsp oil
salt
80 g macaroni
400 g tinned tomatoes, chopped
3 onions (150 g), finely chopped
basil
thyme
salt and pepper
1 tbsp oil to grease the dish
450 g courgettes, sliced
150 g soured cream
2 eggs
100 g grated Cheddar cheese

1. Place the water, oil and salt into the bowl, cover and bring to the boil.

3-4 Min. ☼ 800 W

2. If you have the sort of macaroni that is sold in long strips, break it up into small pieces, add to the boiling water, stir and cook.

8-10 Min. ☼ 240 W

Drain the past and allow to cool.

3. Mix the tomatoes and the onions and season well. Grease the dish. Place the macaroni into the dish and pour the tomato sauce on top. Place the slices of courgette on the top of that.

4. Beat the soured cream with the eggs and pour over the dish. Sprinkle the grated cheese on top.

1. **30-35 Min. ☼ 800 W**2. **5-6 Min. ☼**

Allow the dish to stand for 5-10 minutes after cooking.

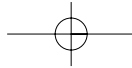

· SERVICE NIEDERLASSUNGEN · ADDRESSES D'ENTRETIEN · ONDERHOUDSADRESSEN · DIRECCIONES DE SERVICIO · INDIRIZZI DI SERVIZIO ·

ÖSTERREICH

Bei einer Reklamation Ihrer SHARP Mikrowelle wenden Sie sich bitte an Ihren Fachhändler oder an eine der nachfolgend aufgeführten SHARP SERVICE Niederlassungen.

Manfred Mayer GmbH, Stipcakgasse 6, 1234 Wien, Phone: 01-6093120, Fax: 01-6993629 / **MCL-Service GmbH**, Deutschstr. 19, 1232 Wien, Phone: 01-6168800, Fax: 01-6168800-15 / **Karl Rother**, Simmeringer Hauptstr. 11, 1110 Wien, Phone: 01-7498432, Fax: 01-7498432-12 / **Roland Göschl**, Bayerhamerstr. 12c, 5020 Salzburg, Phone: 662-882307, Fax: 662-881926 / **Franz Schuhmann**, Gablonzerweg 18, 4030 Linz, Phone: 732-382280, Fax: 732-382280-8 / **Arnold Moser**, An der Heufurt 28, 6900 Bregenz, Phone: 5574-75777, Fax: 5574-75777 / **Anton Reitmeir**, Leopoldstr. 57, 6020 Innsbruck, Phone: 512-562277, Fax: 512-562277 / **Scheuermann**, Rennsteinerstr. 8, 9500 Villach, Phone: 4242-21174, Fax: 4242-21174 / **Pichler**, Am Wagrain 342, 8055 Graz, Phone: 316-291292, Fax: 316-291292 / **Audio Video Service**, Sonnengasse 13, 9020 Klagenfurt, Phone: 463-43114, Fax: 463-43113

BELGIUM

En cas d'une réclamation concernant une four a micro-onde SHARP, nous vous prions de vous adresser à votre spécialiste ou à une adresse des SHARP Services suivantes.

Indien uw magnetron problemen geeft kunt u zich wenden tot uw dealer of een van de onderstaande Sharp service centra.

SHARP ELECTRONICS, Phone: 0900-10158, Web: <http://www.sharp.be>

AVTC, Kleine Winkellaan 54, 1853 Strombeek-Bever, Phone: 02/2674019, Fax: 2679670,

ETS HENROTTE, Rue Du Campinaire 154, 6240 Farciennes, Phone: 071/396290, Fax: 391237

Nouvelle Central Radio (N.G.R) Rue des Joncs 15 L-1818 HOWALD Phone: 00352404078, Fax. 2402085

NEDERLAND

Indien uw magnetron problemen geeft kunt u zich wenden tot uw dealer of naar onderstaand Sharp Service Centrum.

SHARP ELECTRONICS BENELUX BV, - Helpdesk - Postbus 900, 3990 DW Houten, Telefoon: 0900-7427723,

Web: <http://www.sharp.nl>

DEUTSCHLAND

Bei einer Reklamation Ihrer SHARP Mikrowelle wenden Sie sich bitte an Ihren Fachhändler oder an eine der nachfolgend aufgeführten SHARP SERVICE Niederlassungen.

03048 Groß Garglow, Cottbuser Str. 129, Bernd Mindach, Tel: 0355-539987, Fax: 0355-5265685 / **04159 Leipzig**, Max-Liebermann-Straße 4a, Rudi Franz, Tel: 0341-9112525, Fax: 0341-9112526 / **04600 Altenburg**, Gabelentzstraße 15A, Mechanik Altenburg E.G., Tel: 03447-311102, Fax: 03447-315253 / **06217 Merseburg**, Gotthardstraße 30, "Looke & May, GmbH", Tel: 03461-214121, Fax: 03461-216891 / **06295 Eisleben**, Hallesche Straße 36, Hausger. Kundend. Eisleben, Tel: 03475-603079, Fax: 03475-747262 / **06618 Naumburg**, Wenzelstraße 15, "Hausgeräte & Service, GmbH", Tel: 03445-202016, Fax: 03445-202016 / **06844 Dessau**, Albrechtstraße 116-118, "Dessau-Electric, GmbH", Tel: 0340-261270, Fax: 0340-213332 / **07407 Rudolstadt**, Emil Hartmann Straße 2, Elektro Ernst Granowski, Tel: 03672-352123, Fax: 03672-357097 / **07545 Gera**, Amthorstraße 12, "Ess Hardware Service, GmbH", Tel: 0365-8820115, Fax: 0365-8820116 / **07973 Greiz**, Reichenbacher Straße 44d, Elektro Riederer Haushaltgeräte, Tel: 03661-3148, Fax: 03661-430142 / **08280 Aue**, Bahnhofstraße 21, "EHS Elektro-Hausgeräte SVC, GmbH", Tel: 03771-552222, Fax: 03771-552255 / **08523 Plauen**, Weststraße 63, "Elektrotechnik Plauen, GmbH", Tel: 03741-2120, Fax: 03741-212259 / **09221 Neukirchen**, Hauptstraße 74, Walther Elektro, Tel: 0371-217096, Fax: 0371-217090 / **09246 Pleiße**, Zeppelinstraße 8a, "Hans Krempel Haustechnik, GmbH", Tel: 03722-73780, Fax: 03722-737822 / **09328 Lunzenau**, Schulstraße 6, "Peter Welsch, GmbH", Tel: 037383-6434, Fax: 037383-6448 / **09376 Oelsnitz**, Bahnhofstraße 43, "Elektrotechnik Oelsnitz, GmbH", Tel: 037298-2677, Fax: 037298-2678 / **12157 Berlin**, Cranachstraße 2, Michael Kittler, Tel: 030-85602602, Fax: 030-85602603 / **16866 Kyritz**, Hamburgerstr. 31, "Schumacher Haustechnik, GmbH", Tel: 033971-54137, Fax: 033971-54137 / **18055 Rostock**, Timmermannstrat 5, Hetec, Tel: 0381-36231, Fax: 0381-36231 / **18435 Stralsund**, Kedingshäger Straße 78, "RDS Haushaltsgeräte, GmbH", Tel: 03831-391426, Fax: 03831-390121 / **20357 Hamburg**, Schulterblatt 132, Dieter Möller, Tel: 040-435332, Fax: 040-4302120 / **20537 Hamburg**, Eiffestraße 398, "Deubel+Höfermann Electronic, GmbH", Tel: 040-41365200, Fax: 040-41365299 / **22459 Hamburg**, Seesrein 35, Dieter A. Volbrecht VDI Klima und Kälte Service, Tel: 040-5517331, Fax: 040-5519996 / **23562 Lübeck**, Helmholtzstraße 12, Lutz H. Boenisch, Tel: 0451-51929, Fax: 0451-56787 / **24116 Kiel**, Eckernförder Straße 93, "Jürgen Skop, GmbH", Tel: 0431-13038, Fax: 0431-13811 / **24357 Fleckeby**, Südring 14, "Kaack Elektro-Haushaltgeräte Service, GmbH", Tel: 04354-700, Fax: 04354-1311 / **24975 Husby**, Flensburger Straße 41, Günter Josten, Tel: 04634-422, Fax: 04634-723 / **25770 Hemmingstedt**, Koesliner Straße 18, Dirk Stübner Diethmarscher Hausgeräte Service, Tel: 0481-64943, Fax: 0481-64764 / **26655 Westerstede**, Südring 37, "Gerhard Ahrenholtz, GmbH", Tel: 04488-84770, Fax: 04488-847711 / **27404 Heeslingen**, Kirchstraße 9-11, Helmut Willenbrock Elektro-Kälte-Radio, Tel: 04281-1031, Fax: 04281-6467 / **27478 Cuxhaven**, Am Kanal 5, Oskar Wieandt & Sohn OHG, Tel: 04724-81300, Fax: 04724-813050 / **28207 Bremen**, Neidenburger Straße 20, "Hansa Haushaltsgeräte Service, GmbH", Tel: 0421-492526, Fax: 0421-440932 / **29439 Lüchow**, Güldenboden 25, Elektro-Kittler, Tel: 05841-709779, Fax: 05841-709780 / **30926 Seelze**, Lange-Feld-Straße 122, Strickling Werkkundendienst, Tel: 0511-4003999, Fax: 0511-40039920 / **34123 Kassel**, Heinrich-Hertz-Straße 9, Kältebetrieb v. Rappard, Tel: 0561-5809545, Fax: 0561-5809570 / **34128 Kassel**, Ahnatalstraße 84, Elektro Mohrhenne, Tel: 0561-61727, Fax: 0561-65470 / **35037 Marburg**, Wilhelmstraße 16, Hans-Georg Fuchs, Tel: 06421-22424, Fax: 06421-27549 / **35415 Pohlheim**, Ludwigstraße 13-15, Jung KDZ, Tel: 06403-61131, Fax: 06403-62151 / **36088 Hünfeld**, Hauptstr. 22, Elektro Vogt, Tel: 06652-2215, Fax: 06652-5782 / **37671 Hötter**, Krämerstraße 8, Elektro Nonn, Tel: 05271-7959, Fax: 05271-35053 / **38444 Wolfsburg**, Brandgehaege 5 C, Gärtner Elektro-Haustechnik, Tel: 05308-4070, Fax: 05308-40740 / **39106 Magdeburg**, Ankerstr. 9, "Industrie-Elektronik Magdeburg, GmbH", Tel: 0391-5430402, Fax: 0391-5433520 / **40476 Düsseldorf**, Rother Straße 21, Horst Leven, Tel: 0211-486025, Fax: 0211-443399 / **41065 Mönchengladbach**, Gutenbergstraße 28, Horst Hommers Kundendienst-Center, Tel: 02161-603256u.57, Fax: 02161-651951 / **42781 Haan**, Talstraße 8b, Horst Kerkühn Elektro-Haustechnik, Tel: 02129-4466+53550, Fax: 02129-34037 / **44869 Bochum**, Ruhrstraße 181, "ML Werks-Service, GmbH", Tel: 02327-77899, Fax: 02327-74692 / **45219 Essen**, Corneliusstraße 39, R. Drengenburg, Tel: 02054-84114, Fax: 02054-15238 / **46045 Oberhausen**, Feldmannstraße 76, Dieter Kroppen, Tel: 0208-871711, Fax: 0208-876652 / **48165 Münster-Hiltrup**, Rohrkampstraße 23, Günter Pfeifer Großküchentechnik, Tel:

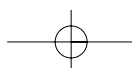

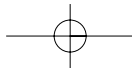

· SERVICE NIEDERLASSUNGEN · ADDRESSES D'ENTRETIEN · ONDERHOUDSADRESSEN · DIRECCIONES DE SERVICIO · INDIRIZZI DI SERVIZIO ·

02501-3033, Fax: 02501-24277 / **49324 Melle, Plettenberger** Straße 50, "H. U. Borgards, GmbH", Tel: 05422-949740, Fax: 05422-949792 / **51598 Friesenhagen**, Mühlenhof 6, "Hans Krempel Haustechnik, GmbH", Tel: 02734-7377, Fax: 02734-40618 / **52146 Würselen**, De Gasperistraße 6+10, Hubert Hamacher, Tel: 02405-9600+9609, Fax: 02405-2704 / **53757 Sankt Augustin**, Bussardstraße 120, "HDL Elektro-Kundendienst, GmbH", Tel: 02241-920330, Fax: 02241-920334 / **55130 Mainz**, Nur telefonische Annahmestelle, "Norbert Schwamb, GmbH", Tel: 06131-881070 / **55543 Bad Kreuznach**, Industriestraße, "Hans Krempel Haustechnik, GmbH", Tel: 0671-794335, Fax: 0671-794369 / **56070 Koblenz**, August-Horch-Straße 14, "Hans Krempel Haustechnik, GmbH", Tel: 0261-8909173, Fax: 0261-8909199 / **57080 Siegen**, Gosenbacher Hütte 44, "Hans Krempel Haustechnik, GmbH", Tel: 0271-354114, Fax: 0271-351408

58239 Schwerte, Holzener Weg 79, "HKT Electronica 2000 Josef Schlütz, GmbH", Tel: 02304-982100, Fax: 02304-86360 / **59457 Werl**, Westdahler Weg 2, MAYER Electro, Tel: 02922-3541, Fax: 02922-85382 / **61381 Friedrichsdorf**, Bahnstraße 17 a, O. Hollmann, Tel: 06172-778276, Fax: 06172-75883 / **63739 Aschaffenburg**, Maximilianstraße 8, Radio-Fernseh Reis, Tel: 06021-15177, Fax: 06021-15199 / **65239 Hochheim**, Eltviller Straße 14, "Norbert Schwamb, GmbH", Tel: 06146-4085, Fax: 06146-4088 / **65627 Elbthal-Hangenmeilingen**, Am Ohlenrod 10, Rudi Wagner, Tel: 06436-3444, Fax: 06436-941387 / **65931 Frankfurt**, Nur telefonische Annahmestelle, "Norbert Schwamb, GmbH", Tel: 069-371525 / **66117 Saarbrücken**, Zinzinger Straße 13, "Hans Krempel Haustechnik, GmbH", Tel: 0681-5008522, Fax: 0681-5008533 / **67434 Neustadt**, Saarlandstraße 55, "Hans Krempel Haustechnik, GmbH", Tel: 06321-83077, Fax: 06321-83077 / **68309 Mannheim**, Heppenheimerstraße 23, "Hans Krempel Haustechnik, GmbH", Tel: 0621-7184621, Fax: 0621-7184628 / **68526 Ladenburg**, Am Sägewerk 2, Elektro Service Salinger, Tel: 06203-3341, Fax: 06203-16919 / **70186 Stuttgart**, Klippeneck Straße 1, Elektro Herterich Techn. Kundendienst, Tel: 0711-4687023, Fax: 0711-4687024 / **75236 Kämpfelbach**, Goethestraße 19, Horst Frei, Tel: 07232-1518, Fax: 07232-5238 / **76185 Karlsruhe**, Lotzbeckstraße 9, Electronic Service Franke, Tel: 0721-5700720-23, Fax: 0721-5700736 / **76872 Winden**, Hauptstraße 103, "Hans Krempel Haustechnik, GmbH", Tel: 06349-8571, Fax: 06349-3390 / **78462 Konstanz**, Nur telef. Annahmestelle, Elektro Herterich, Tel: 07531-27923 / **78737 Fluorn-Winzeln**, Schafbaumstraße 9, Edmund Schneider, Tel: 07402-482, Fax: 07402-8014 / **79650 Schopfheim**, Feldbergstraße 21, R. Grossmann, Tel: 07622-674510, Fax: 07622-61900 / **80339 München**, Schwanthalerstraße 110, Kessel & Schnitt, Tel: 089-505802, Fax: 089-5021596 / **85095 Denkendorf/Zandt**, Michlstraße 3, Elektro Pfeiffer, Tel: 08466-1319, Fax: 08466-1319 / **86157 Augsburg**, Stadlberger Straße 67, J. Haslinger Elektro-Geräte Kundendienst, Tel: 0821-523125, Fax: 0821-526664 / **87439 Kempten**, Heiligkreuzer Straße 17, Radio Hartmann, Tel: 0831-594646, Fax: 0831-91319 / **89231 Neu-Ulm**, Gartenstraße 4, Elektrotechnik Schneider, Tel: 0731-85897, Fax: 0731-74681 / **91522 Ansbach**, Am Ring 17, "Elektro Merk, GmbH", Tel: 0981-89574, Fax: 0981-86715 / **92820 Feucht/Nürnberg**, Friedrich-Ebert-Straße 21, "Herbert Geissler, GmbH", Tel: 09128-7076-0, Fax: 09128-707636 / **93102 Pfatter**, Regensburger Straße 60, Franz Bernhard, Tel: 09481-90060, Fax: 09481-90061 / **94130 Oberzell**, Hameler Straße 31, Elektro Service Schurig, Tel: 08591-2400, Fax: 08591-1285 / **96052 Bamberg**, Aronstraße 2a, Bernhard Jackl, Tel: 0951-9370245, Fax: 0951-9370247 / **97070 Würzburg**, Untere Johannitergasse 16, "Radio Wels City Service, GmbH", Tel: 0931-3557119, Fax: 0931-14151 / **97318 Kitzingen**, Herrstraße 4-6, "Hoffritz, GmbH", Tel: 09321-4221-32021, Fax: 09321-32185 / **98724 Neuhaus**, Eisfelder Straße 32, "DLC Haustechnik, GmbH", Tel: 03679-79060, Fax: 03679-790620 / **99096 Erfurt**, Goethestraße 14, Ernst Grüsser, Tel: 0361-3465719, Fax: 0361-3465719 / **99734 Nordhausen**, Töpferstraße 10, "Südharzer Dienstleistungs-Gesellschaft, GmbH", Tel: 03631-983651, Fax: 03631-983654 / **99817 Eisenach**, Bahnhofstraße 17, "Blitz Elektro-Elektronik, GmbH", Tel: 03691-292930, Fax: 03691-292915

FRANCE

En cas de réclamation pour les fours micro-ondes SHARP, nous vous prions de vous adresser à votre spécialiste ou à l'une des stations techniques agréées SHARP suivantes :

A.A.V.I. : 1, Rue du Mont de Terre, 59818 Lesquin Cédex. Tél : 03 20 62 18 98 - Fax : 03 20 86 20 60. Départements desservis : 02, 08, 59, 62, 80 / **ASYSTEC** : P.A. Charles de Gaulle, 4 rue des Artisans, 95190 Goussainville. Tél : 01 39 88 80 00 - Fax : 01 34 38 91 20. Départements desservis : 60, 77, 93, 95 / **ATELIER ROUSSEL** : 12, Bld Flandre Dunkerque, 56100 Lorient. Tél : 02 97 83 07 41 - Fax: 02 97 87 02 36. Départements desservis : 22,29,35,44,56 / **C.E.A.T.** : 9, Rue de Venise, 21000 Dijon. Tél : 03 80 66 15 57 - Fax: 03 80 67 12 36. Départements desservis : 10,21,25,39,52,58,71,89 / **C.M.T.S.** : 38, Rue des Ormeaux, 75020 Paris. Tél : 01 43 70 20 00 - Fax: 01 43 70 36 46. Départements desservis : 75,77,78,91,92,93,94,95 / **C.T.E.** : Zone Tilly - 116 rte de Thionville, 57140 Woippy. Tél : 03 87 30 14 14 - Fax: 03 87 30 85 07. Départements desservis : 51,54,55,57,88 / **ELECM A** : 6 Bld Guéidon, 13013 Marseille. Tél : 04 91 06 22 56 - Fax: 04 91 06 22 90. Départements desservis : 13,26,30,34,43,48,83,84 / **ELECTRO SERVICE** : 21 rue de Mulhouse, BP 122, 68313 ILLZACH. Tél : 03 89 62 50 00 - Fax : 03 89 50 80 14. Départements desservis : 67,68,70,90 / **M.E.C.** : 118 Bld Tonnelé, 37020 Tours. Tél : 02 47 77 90 90 - Fax : 02 47 77 90 91. Départements desservis : 18,36,37,41,45,44,49,79,85,86 / **M.R.T.** : 74, Rue Albert Einstein, 72021 Le Mans Cedex. Tél : 02 43 28 52 20 - Fax: 02 43 24 93 81. Départements desservis : 28,53,61,72 / **ROSSIGNOL** : ZI du Brezet Est, 6 rue P. Boulanger,63100 Clermont Ferrand. Tél : 73 91 93 09, Fax:73 92 28 79. Départements desservis : 3, 15, 19, 23, 43, 63 / **SETELEC** : 23, Rue du Chatelet,76420 Bihorel les Rouen. Tél : 35 60 64 39 - Fax:35 59 93. 48. Départements desservis : 14,27,50,76 / **S.T.E.** : 3, Chemin de l'Industrie,06110 Le Cannet Rocheville. Tél : 93 46 05 00 - Fax: 93 46 51 18. Départements desservis : 04,06 / **S.T.V.S.** : 18, Rue Benoit Malon,42000 Saint Etienne. Tél : 77 32 74 57, Fax: 77 37 45 29. Départements desservis : 03,07,42,43,63 / **S.T.V.S.** : 10, Chemin Saint-Gobain ,69190 Saint Fons. Tél : 78 70 03 32 - Fax: 78 70 86 61. Départements desservis : 01,38,69,71,73,74 / **TECH SERVICE** : Batiment G-impasse Boudeville, 31100 Toulouse. Tél : 61 44 98 45 - Fax: 62 14 16 13. Départements desservis : 09,11,31,32,33,40,47,64,65,66,81,82 / **TIMO VIDEO** : 29 rue Elisabeth,91330 Yerres. Tél : 69 48 04 80 - Fax: 69 83 36 10. Départements desservis :28, 45, 77, 89, 912, 94 / **U.N.T.D.** : 1, Rue des Lourdines, 76000 Rouen. Tél : 35 72 28 04 - Fax: 35 73 18 32. Départements desservis :14,27,50,76

ITALIA

NEL CASO SI VERIFICASSERO PROBLEMI ALLA VOSTRA APPARECCHIATURA POTRETE RIVOLGERVI PRESSO UN NOSTRO CENTRO DI ASSISTENZA AUTORIZZATO SHARP

C.A.T. Di Bellone, Via Dell'areoport, 76, 64100, Teramo, Tel: 0861415745, Fax: 0861212117 / **C.R. Elettronica**, Via Amiternum 38, 67100, L'aquila, Tel: 0862-321442, Fax: 0862-314323 / **Elettrovideo Snc**, Via Tiburtina V. 64, 65124,Pescara, Tel: 08552020, Fax: 085-52020 / **Riccardi Cosimo**, Via S.Stefano 51, 75100, Matera, Tel: 0835-333671, Fax: 0835-333671 / **Ld Service Di Lavano E De Biasi**, Via Viviani 2, 85100, Potenza, Tel: 0971-472578, Fax: 0971-472578 / **Cozzupoli & Crupi Snc**, Via R. Campi Primo Tronco 103, 89126, Reggio Calabria, Tel: 0965-24022, Fax: 0965-310778 / **Ater Snc**, Via Naz.Pentimele 159/A-B, 89100, Reggio Calabria, Tel: 0965-47051, Fax: 0965-47855 / **Audiovideo Snc**, Via A. De Gasperi 44, 88018, Vibo Valentia, Tel: 0963-45571, Fax: 0963-45572 / **Battaglia Saverio**, Via C. Colombo 85, 88063, Catanzaro, Tel: 0961-33824, Fax: 0961-737337 /

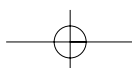



· SERVICE NIEDERLASSUNGEN · ADDRESSES D'ENTRETIEN · ONDERHOUDSADRESSEN · DIRECCIONES DE SERVICIO · INDIRIZZI DI SERVIZIO ·

Ciano Giuseppe, Via Circonvallaz.Sud, 89029, Taurianova Rc, Tel: 0966-643483, Fax: 0966-614946 / **Lab. Tv Dei F.Lli Aiello Snc**, Via Torino 121/123, 88074, Crotone Cz, Tel: 0962-20889, Fax: 0962-24254 / **Mea Giuseppe**, Via L. Einaudi Trav.I 16, 88048, Lamezia T. (Cz), Tel: 0968-437520, Fax: 0968-437520 / **Medaglia Giolindo**, Via Torrazzo 60/62, 88063, Catanzaro Lido, Tel: 0961-31626, Fax: 0961-31626 / **S.A.T.E Di Dodaro**, Via Degli Stadi 28/F, 87100, Cosenza, Tel: 0984-482337, Fax: 0984-482337

Se.Ri.El.Co., V.Delle Medaglie D'oro 163, 87100, Cosenza, Tel: 0984-33152, Fax: 0984-33152 / **Satep Srl**, Via Naz.Delle Puglie 176/A, 80026, Casoria (Na), Tel: 081-7590161, Fax: 081-7590706 / **Audio Service Snc**, Via Cattaneo 4/6, 81100, Caserta, Tel: 0823-329099, Fax: 0823-353686 / **Drf Eletr.** Di Rubbo, Via M.Pacifico 118, 82100, Benevento, Tel: 0824-62416, Fax: 0824-62416 / **Elettronica D'Argenio**, Via Nazion. Torrette, 195, 83013, Mercogliano (Av), Tel: 0825-681590, Fax: 0825-681590 / **Elettronica Service**, Viale Europa, 15, 80053, Castell. Stabia, Tel: 081-8728280, Fax: 081-8728280 / **Errediesse Service**, Via P. Mascagni 74/76, 80128, Napoli, Tel: 081-5794825, Fax: 081-5791899 / **M.C. Elettronica Snc**, Via Dei Mille 138, 84100, Salerno (Sa), Tel: 089-330591, Fax: 089-336836 / **Menna Elettronica Srl**, Via Nazionale Delle Puglie 294, 80026, Casoria (Na), Tel: 081-5840726, Fax: 081-7594277 / **Satec Di Correria Snc**, Via Liberta' 307, 81024, Maddaloni (Ce), Tel: 0823-341088, Fax: 0823-343011 / **Video Eletr. 2 Di Nasti**, Via Ant.Pio 74/76, 80126, Napoli, Tel: 081-7676300, Fax: 081-7284347 / **Audio Video Center Snc**, Via F. Vandelli 23/29, 41100, Modena, Tel: 059-235219, Fax: 059-210265 / **Ass.Electron Di Fogli**, Via F.Lli Aveni 19, 44100, Ferrara, Tel: 0532-903250, Fax: 0532-903250 / **Ma.Pi. Snc**, Via T.Azzolini 3, 40132, Bologna, Tel: 051-6414115, Fax: 051-406848 / **Masini Service**, Via Mediterraneo 24, 47041, Bellaria (Fo), Tel: 0541-347714, Fax: 0541-324413 / **Nuova Tecnocoop**, Via Armellini 28/30/32, 47037, Bellariva Rimini, Tel: 0541-370812, Fax: 0541-370812 / **Parmaservice Sas**, Via Benedetta 47/A, 43100, Parma, Tel: 0521-271666, Fax: 0521-271666 / **Rimpelli Nelusco Snc**, Via Marchelli 7/C, 42100, Reggio Emilia, Tel: 0522-323740, Fax: 0522-376967 / **Rip.Eletr.Ravenna**, Via Reale, 27/C 48010, Camerlona (Ra), Tel: 0544-521500, Fax: 0544-521100 / **Rte Di I. Cattellani & C.**, Via Premuda 38/V, 42100, Reggio Emilia (Re), Tel: 0522-381277, Fax: 0522-381788 / **Stema Snc**, V.Le Bologna, 92/A 47100, Forlì, Tel: 0543-704475, Fax: 0543-702742 / **Technolab Snc**, Via Romea 36, 48100, Ravenna, Tel: 0544-64008, Fax: 0544-476497 / **Tecnoservice.Com**, Via Longhi 16/A/B, 40128, Bologna, Tel: 051-360986, Fax: 051-366863

A.V.R. Sas Di Di Renzo, Via Colonna 20/8, 33170, Pordenone, Tel: 0434-27669, Fax: 0434-523661 / **Astec S.N.C. Di Zoccarato**, Via Pecenco 4, 34127, Trieste, Tel: 040-574745, Fax: 040-577923 / **Cm Elettronica Snc**, Via G.Galilei 2, 33010, Tavagnacco (Ud), Tel: 0432-572172, Fax: 0432-573788 / **Contr.El.**, Via Rossetti 51/C, 34141, Trieste, Tel: 040-368387, Fax: 040-638117 / **Tecnofly Snc**, Via Cappuccini 11/2, 34170, Gorizia, Tel: 0481-32732, Fax: 0481-546740 / **A.P. Rip. Arduini Piero**, Via Licinio Refice 192, 03100, Frosinone, Tel: 0775-291267, Fax: 0775-291267 / **Centro E.L.Va. Snc**, Via Attilio Mori 19/21, 00176, Roma, Tel: 06-2148641, Fax: 06-2753048 / **E.I.S.A.R.**, Via S.Sotero 36, 00165, Roma, Tel: 06-6380516, Fax: 06-6380973 / **Elettronica 81**, Via Ezio 56/58, 04100, Latina, Tel: 0773-694608, Fax: 0773-663511 / **Italreg Di Abano**, Parco Belvedere Conca 74, 04024, Gaeta, Tel: 0771-470851, Fax: 0771-470851 / **Palmieri F.**, Via S.Polledrara 219, 03100, Frosinone, Tel: 0775-291485, Fax: 0775-291485 / **S.A.R.E. S.R.L.**, Via Barbana 35/37, 00142, Roma, Tel: 06-5406796, Fax: 06-5412736 / **Video Serv. Sas Di Calabrese**, Str Teverina Km 2, 400 L. Pantanese, 01100, Viterbo (Vt), Tel: 0761-251557, Fax: 0761-251558 / **Caudullo Salvatore**, Via Cavour 11/R, 17100, Savona, Tel: 019-8386251, Fax: 019-829654 / **Centro Assistenza Tecn.**, Via Metella 3, 18039, Ventimiglia (Im), Tel: 0184-239011, Fax: 0184-239015 / **G.A.T.E. Snc**, Passo P.Carrega 24/A, 16141, Genova, Tel: 010-8361543, Fax: 010-8364571

Gse S.R.L., Via Rimassa 183 R, 16122, Genova (Ge), Tel: 010-5536076, Fax: 010-5536113 / **Rapisarda G.**, Via Argine Destro 299, 18100, Imperia, Tel: 0183-710771, Fax: 0183-710771 / **Rien Snc**, Via Valle 17/19, 19124, La Spezia, Tel: 0187-21925, Fax: 0187-21925 / **Tognetti Snc**, Via Lunigiana 589, 19100, La Spezia, Tel: 0187-507656, Fax: 0187-507656 / **A.E. Snc**, V.Acerbi 28, 20161, Milano, Tel: 02-66220906, Fax: 02-6466930 / **A.T. Electronics**, Via G. Da Cermenate 76, 20141, Milano, Tel: 02-89501602, Fax: 02-89502937 / **C.A.T. Bm**, Via Per Desio 22, 20030, Bovisio Masciago Mi, Tel: 0362-558421, Fax: 0362-558887 / **Cat Electronic Snc**, Via Togliatti 8, 20077, Melegnano (Mi), Tel: 02-9834498, Fax: 02-9837559 / **Crel S.N.C.**, Via Carducci, 23100, Sondrio, Tel: 0342-216538, Fax: 0342-216538 / **Electronic's Center**, Via G.Giulini 9, 22100, Como, Tel: 031-279820, Fax: 031-261791 / **Elettronica Cappi**, Via Gorizia, 14/B, 23100, Sondrio, Tel: 0342-210459, Fax: 0342-210459 / **Eurotecnica Di Ronchi**, Via Milano 74/B, 25126, Brescia, Tel: 030-317673, Fax: 030-317673 / **Microcentro**, Via Falloppio 11, 20110, Milano, Tel: 02-26827306, Fax: 02-2826711 / **Morini Daniele**, Via Maiocchi, 10, 27058, Voghera (Pv), Tel: 0383-368740, Fax: 0383-368740 / **Prada Cesare M.Antonio**, Via Riviera 142, 27100, Pavia, Tel: 0382-525920, Fax: 0382-525920 / **S.A.R.E.L. Snc Di Giglia Mario**, Corso 30, 27029, Vigevano (Pv), Tel: 0381-344088, Fax: 0381-344088 / **S.T.A.R.T. Video Hi-Fi**, Via Orti Romani 16/A, 26100, Cremona, Tel: 0372-38731, Fax: 0372-38731 / **Salvadori Claudio**, Via Del Bosco 44, 21052, Busto Arsizio (Va), Tel: 0331-329973, Fax: 0331-628727 / **Service Tva Snc**, Via Vergnano 59, 25127, Brescia, Tel: 030-349885, Fax: 030-349885 / **Tecnovideo Snc**, P.Zza De Gasperi 28, 46100, Mantova, Tel: 0376-321554, Fax: 0376-321554 / **Teletecnica 2000**, Via Torino 21, 21013, Gallarate (Va), Tel: 0331-775519, Fax: 0331-775519 / **Test Tv Snc**, Via S. Altamura 10, 20148, Milano, Tel: 02-4035408, Fax: 02-48704889 / **Video Service Snc**, Via Locatelli 2, 24068, Seriate (Bg), Tel: 035-296883, Fax: 035-300076 / **C.A.T. Snc**, Via A. Cecchi 25, 61100, Pesaro, Tel: 0721-25608, Fax: 0721-25608 / **Digitecnica Di Moroni R. Snc**, Via Zuccarini, 1-Z.Baraccolla, 60131, Candia (An), Tel: 071-2866067, Fax: 071-8046398 / **Marconi Lanfranco**, Via M.Bianco 10-Porto D'ascoli, 63039, S.Bened. D/Tronto, Tel: 0735-659230, Fax: 0735-751155 / **Pluritecnica**, Via C. Ulpiani 5, 63100, Ascoli Piceno, Tel: 0736-342635, Fax: 0736-346405 / **S.A.T. Radio Tv**, Via D. Rossi 32-34, 62100, Macerata, Tel: 0733-231304, Fax: 0733-231304 / **Vitali Claudio**, Via Marconi 89, 60035, Jesi (An), Tel: 0731-59290, Fax: 0731-59290 / **Pesce Luigi**, Via Tiberio 74, 86100, Campobasso, Tel: 0874-63717 / **Alpi Lab**, Via S. Grandis 11, 12100, Cuneo, Tel: 0171-690384, Fax: 0171-690384 / **Arte E Tecnica Snc**, Via Falletti 22, 13900, Biella, Tel: 015-8496250, Fax: 015-8496250 / **Elektro Di Fiore F.**, Via Tripoli 91, 13100, Vercelli, Tel: 0161-250071, Fax: 0161-255843 / **F.G. Elettronica**, Via Sagra S.Michele 46, 10141, Torino, Tel: 011-796423, Fax: 011-796423

Guida Di Guida Alessio, Via Roggiolo 5, 28069, Trecate (No), Tel: 0321-71608, Fax: 0321-777003 / **Mantoan Dario**, Via Matteotti 69, 28062, Cameri (No), Tel: 0321-519078, Fax: 0321-519078 / **Siragusa E Roagna Sdf**, C.So Matteotti 41, 14100, Asti, Tel: 0141-531131, Fax: 0141-531131 / **Videotext**, P.Zza D.Alp.Cuneense 24, 12043, Canale (Cn), Tel: 0173-95878, Fax: 0173-979638 / **A.V.S. Snc**, Via N.Pompilio 61, 72100, Brindisi, Tel: 0831-560165, Fax: 0831-560165 / **Arnesano Faustino**, Via M.Moscardino 10, 73100, Lecce, Tel: 0832-318277, Fax: 0832-318277 / **C.Ass.Tec. Di Columella**, Via Mazzini 30, 71016, San Severo (Fg), Tel: 0882-226295, Fax: 0882-226295 / **Eletr.Serv. Di Marcuccio**, C.So Annibale 15/17, 74100, Taranto, Tel: 099-7721933, Fax: 099-7721933 / **Elitec Service Di Pepe G.**, Viale Ofanto 149-151, 71100, Foggia, Tel: 0881-685013, Fax: 0881-687041 / **Ingresso Fernando**, Via Biasco 15, 73100, Lecce, Tel: 0832-396466, Fax: 0832-392014 / **Marinelli Benedetto**, Via Dei Salici 14, 70051, Barletta (Ba), Tel: 0883-514054, Fax: 0883-527128 / **Massariello Agostino**, Via Numa Pompilio 65, 72100, Brindisi, Tel: 0831-521821 / **Stear Snc Di Pici**, Via E.Perrone 16, 71100, Foggia, Tel: 0881-778483, Fax: 0881-778483 / **Video Serv. Marcantonio**, Via G.M. Giovane 47, 70124, Bari, Tel: 080-5618029, Fax: 080-5618029 / **Zetaclima Di Zumpano**, Via Molfetta 69, 70054,

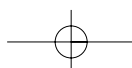

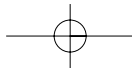

· SERVICE NIEDERLASSUNGEN · ADDRESSES D'ENTRETIEN · ONDERHOUDSADRESSEN · DIRECCIONES DE SERVICIO · INDIRIZZI DI SERVIZIO ·

Giovinazzo (Ba), Tel: 080-3947952, Fax: 080-3947952 / **Sat Di Partipilo**, Via Borsellino E Falcone 17 Bis, 70100, Bari, Tel: 080-5022999, Fax: 080-5022992 / **Base Elettronica**, Via G. Curreli, S.N., 09170, Oristano, Tel: 0783-310049, Fax: 0783-212081 / **Chip Elettronica S.R.L.**, Via Salvator Rosa 26, 09100, Cagliari, Tel: 070-521338, Fax: 070-506074 / **Co.Ri.Fr.El. 2 Snc**, Via Del Castagno Settore D, 07026, Olbia - Zona Cerasarda

Co.Ri.Fr.El. Snc, Via Monastir 112, 09122, Cagliari, Tel: 0789-562104, Fax: 0789-9562105 / **Floris Sergio**, Via Mazzini 56, 09010, Gonnessa (Ca), Tel: 0781-45436, Fax: 0781-469198 / **G.S. Elettronica**, Via Della Resistenza 5, 08100, Nuoro, Tel: 0784-203084, Fax: 0784-203060 / **Hi-Fi Center**, Via Lucania 15, 07026, Olbia (Ss), Tel: 0789-22164, Fax: 0789-200366 / **Matta Paolo**, Via Risorgimento 166/A, 09134, Cagliari-Pirri, Tel: 070-520856, Fax: 070-524148 / **Videoelettronica Snc**, Via Torino 18, 07100, Sassari, Tel: 079-276616, Fax: 079-273239 / **A.T.El. Di G.Amico**, L.Go Scarlatti 30, 93100, Caltanissetta, Tel: 0934-591955, Fax: 0934-552999 / **A.V.S.**, Via Sassari, 2/C, 95100, Catania, Tel: 095-446696, Fax: 095-434337 / **Alamia Service**, C.So Pisani, 310/312, 90129, Palermo, Tel: 091-6570502, Fax: 091-6575761 / **Euroservice 2000 (Ex Aloisi)**, Via Marettimo 36, 91025, Marsala (Tp), Tel: 0923-713459, Fax: 0923-718592 / **Arte Tv E C. Snc**, Via G.Centorbi 17, 91026, Mazara Del Vallo, Tel: 0923-908160, Fax: 0923-670035 / **Centro Ass. Tec. Di Bacchi I.**, P.Za A. Giglia 40, 92026, Favara (Ag), Tel: 0922-420311, Fax: 0922-421545 / **Cuppari Electr.**, Via S.Agostino Is 265, 98100, Messina, Tel: 090-672064, Fax: 090-672065 / **Di Fonzo F.E Figli Snc**, Via Ruggero Loria 4/6, 90100, Palermo, Tel: 091-363578, Fax: 091-362853 / **Elettronica Di Di Tullio**, Via Carlentini 40/A, 96100, Siracusa, Tel: 0931-758602, Fax: 0931-758602 / **Tecnica Sud S.N.C.**, V.Le Regina Elena 225/227, 98100, Messina, Tel: 090-40037, Fax: 090-52831 / **Tecnico Siracusana**, V.P.Novelli 71, 96100, Siracusa, Tel: 0931-39440, Fax: 0931-36294 / **Torrisi Michele**, Via Novara 45, 95128, Catania, Tel: 095-445561, Fax: 095-448628 / **Vullo Michele**, Via Gorizia 16, 93100, Caltanissetta, Tel: 0934-551367, Fax: 0934-551367 / **A.T.E.S. Di Zappia L.**, Via Torino 3/A, 57124, Livorno, Tel: 0586-859566, Fax: 0586-859565 / **Belcari Nolberto**, Via J. Gagarin 70, 56012, Pisa, Tel: 0587-420273, Fax: 0587-420273 / **Centi Franco**, Via Bronzino 19/21-R, 50142, Firenze, Tel: 055-710388, Fax: 055-710388 / **Cre Carradori Snc**, Via Dei Macelli 1, 51100, Pistoia, Tel: 0573-28284, Fax: 0573-32413 / **D'amicis Gennaro**, Via P.Pisana 71, 57100, Livorno, Tel: 0586-400564, Fax: 0586-409724 / **Elettronica Rnp**, Via Romana 731, 55100, Lucca, Tel: 0583-956225, Fax: 0583-956225 / **Goti Arcangelo**, Via Magellano 42/A, 52100, Arezzo, Tel: 0575-900819, Fax: 0575-900819 / **Lab.Riparaz. Falchi M.**, Via A. Garibaldi 22-D, 57025, Piombino (Li), Tel: 0565-49400, Fax: 0565-227161 / **Lab.Tv Arrighi**, Via F.Lli Cervi 26/28, 50057, P.A Elsa Empoli(Fi), Tel: 0571-931327, Fax: 571931327 / **M2 Elettronica**, Via Danimarca 3, 58100, Grosseto, Tel: 0564-454571, Fax: 0564-454571 / **Na.To.Ma Snc**, Via Del Sabotino 13, 58100, Grosseto, Tel: 0564-456229, Fax: 0564-456229 / **Pa.Ri.El.S.**, Via B. Tolomei 9, 53100, Siena, Tel: 0577-51159, Fax: 0577-589454 / **Saec Di Coppa**, Via Degli Artigiani 36, 54100, Massa, Tel: 0585-251724, Fax: 585791177 / **Tele Service Di Benvenuti**, Via F. Busoni 3/B, 50018, Scandicci, Tel: 055-753974, Fax: 055-7350267 / **Videoservice Di Genuardi**, Via Borgaccio 72, 53036, Poggibonsi (Si), Tel: 0577-983181, Fax: 0577-996382 / **Bardazzi Paolo**, Via Forlanini 8dr, 500127, Firenze, Tel: 055-4376776, Fax: 055-431956 / **Dal Pozzo Enzo**, Via Barletta 8, 39100, Bolzano, Tel: 0471-913290, Fax: 0471-913290 / **Melone Giuseppe**, Via Zara 44, 38100, Trento, Tel: 0461-235166, Fax: 0461-267210 / **Sighel Mauro**, Via A. Volta 92, 38100, Trento, Tel: 0461-935919, Fax: 0461-935919 / **Tecnoservice Snc**, Via San Vigilio 64/B-C-D, 39100, Bolzano, Tel: 0471-289062, Fax: 0471-261559 / **Quondam C. Stefano**, Via Del Rivo 33, 05100, Terni, Tel: 0744-301512, Fax: 0744-301512 / **Tecnoservice Eletr.**, Via Madonna Alta 185, 06100, Perugia, Tel: 075-5003089, Fax: 075-5003089 / **C.A.T. Di D'isanto**, C.So Ivrea 82/A, 11100, Aosta, Tel: 0165-364056, Fax: 0165-235910 / **Ass.Eletr.Campi Snc**, Via E.Reginato 87, 31100, Treviso, Tel: 0422-436245, Fax: 0422-435996 / **D.D. Assistenza Tecnica**, Via Mondin 11, 32100, Belluno, Tel: 0437-30240, Fax: 0437-939916 / **Di Service Di Dal Lago**, Via Giarretta 33, 36100, Vicenza, Tel: 0444-566662, Fax: 0444-966239 / **G.F.L. S.R.L.**, Via D. De Massari 10, 37045, Legnago, Tel: 0442-602020, Fax: 0442-602021 / **L'elettronica Piu' Snc**, Via Gaspare Campo 18, 45100, Rovigo, Tel: 0425-33221, Fax: 0425-33221 / **Pieffe Di Premier F.**, Via Zermanese 6/B, 31100, Treviso, Tel: 0422-321054, Fax: 0422-321054 / **Pierrezza Carlo**, Via Barrocco Dal Borgo 4, 35100, Padova, Tel: 049-8643266, Fax: 049-8643266 / **Sat Di Galber E C. Snc**, Via Catarinetti 1/E, 37136, Verona, Tel: 045-509609, Fax: 045-509699 / **Speedy Service**, Viale Europa 42/B, 36016, Thiene Vi, Tel: 0445-368235, Fax: 0445-379028 / **Tecno Futura Di Rossi**, Via Delfinato 8 (Laboratorio), 35127, Camin (Pd), Tel: 049-9129469, Fax: 049-9126147 / **Video Service**, Via Vitruvio 11, 37100, Verona, Tel: 045-566299, Fax: 045-573865 / **Video Tv 17323**, Via S. Marco 1818, 30019, Sittomarina (Ve), Tel: 041-5541675, Fax: 041-5541675 / **Vignando Luigino**, Via Dell'industria 18, 30020, Gruaro (Ve), Tel: 0421-74472, Fax: 0421-72923 / **Zaffalon Urbano**, Cas.Calle Corraz. 3849, 30122, Venezia, Tel: 041-2750670, Fax: 041-2757273

ESPAÑA

En caso de una reclamación con vuestra SHARP Microwave, preguntan por favor la casa dónde han comprado su máquina o infórmanse en una de las SHARP Service casas siguientes.

Merino Nicolas Jose A., - 945/ 25.18.92 - Av Judizmendi 24, 01003 Vitoria-Gasteiz, Alava / **Tele-Color** - 96/585.24.60, Cl Del Vent 9, 03500 Benidorm, Alicante / **Telecom Electronica** - 96/539.50.21, Cl Hernan Cortes 8, 03600 Elda, Alicante / **Eurosat S.L.** - 96/525.80.40, Cl Montero Rios 33 03013 Alicante / **Electronica Gomez** - 96/ 546.75.81, Cl Baltasar Tristany 100, 03201 Elche, Alicante / **Angel Avellan Puig** - 965/ 21.32.55, Cl Poeta Quintana 13, 03004 Alicante / **Electronica Eler** - 965/ 25.63.32, Cl Pinoso 8, 03012 Alicante / **Insat**, Cb - 971/ 36.53.18, Cl Pintor Calbo 30, 07703 Mahon, Baleares (Menorca) / **Reparaciones Ortega** - 971/ 39.01.55, Cl Via Punica 33, 07800 Ibiza, Baleares (Ibiza). / **Audio Imagen** - 971/ 31.46.59, Cl Jose Riquer Llobet 8, 07800 Ibiza, Baleares (Ibiza) / **Irtesa Electronica** - 971/ 20.47.02, Cl Jaume Ferran 72 Bjos, 07004 Palma De Mallorca, Baleares (Mallorca) / **Instalaciones Maes**, S.L - 971/ 27.49.47, Cl Son Nadal 63, 07008 Palma De Mallorca, Baleares (Mallorca) / **Electron**. **Pons Gomila Sa** - 971/ 37.22.76, Cr Nueva 162, 07730 Alayor, Baleares (Menorca) / **Jose Marques Anglada,S.L.** - 971/ 38.54.54, Cl Lepanto 19, 07760 Ciudadela, Baleares (Menorca) / **Anoia Electrovisio** - 93/ 805.11.90, Av Balmes 12, 08700 Igualada, Barcelona / **Audio Vision** - 385.78.08, Cl Mare Deu Montserrat 22, 08922 Sta.Coloma, Barcelona / **Sac-2, S.C.P.** - 331.77.54, Cl Riera Blanca 113, 08028 Barcelona / **Fermo** - 465.22.00, Av Morera 5, 08915 Badalona / **Elec.Safont** - 821.30.03, Cl Gral. Manso Sola 31, 08600 Berga, Barcelona / **Servinters, S.C.C.L.** - 389.44.60 - Pz Casagemes 20, 08911 Badalona / **Tecnik's, S.C.P.** - 630.11.20, Cl Joan Bardina 32, 08830 Sant Boi De Ll, Barcelona / **Ce. Va. Sat, S.C.** - 785.51.11, Cr Matadepera 87, 08225 Terrassa, Barcelona / **Laurea S.A.T.** - 889.02.48, Cl Guillerries Bis 20, 08500 Vic, Barcelona / **Ce. Va. Sat, S.C.** - 710.76.13, Ps Rubio I Ors 105, 08203 Sabadell, Barcelona / **Villaret Polo Ramon** - 798.02.48, Cl Moli De Vent 21, 08303 Mataro, Barcelona / **Estarlich Pradas Vicente** - 766.22.33, Cl Industria 131, 08370 Calella, Barcelona / **Videocolor** - 93/ 454.99.08, Cl Villarrol 44, 08011 Barcelona / **Elde** - 872.85.42, Cl Bruch 55, 08240 Manresa, Barcelona / **Pulgar I Edo S.L.** - 93/ 436.44.11, Cl Castillejos 333, 08025 Barcelona / **Electronica Mateos** - 849.28.77, Cr De Caldas (Bajos) 76, 08400 Granollers, Barcelona / **Antonio Robles Sanchez** - 872.55.41, Cl Sant Bartomeu 42, 08240 Manresa, Barcelona / **Top Electronica**, 890.35.91, Cl Misser Rufet 4 Bjos, 08720 Vilafranca Penedes, Barcelona / **La Clinica Del Electrod.**, 93/ 236.44.11, Cl Balmes 160, 08008 Barcelona / **Fix Servicio**

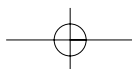



· SERVICE NIEDERLASSUNGEN · ADDRESSES D'ENTRETIEN · ONDERHOUDSADRESSEN · DIRECCIONES DE SERVICIO · INDIRIZZI DI SERVIZIO ·

Tecnico, 675.59.02, Cl Sant Ramon 3 L-2, 08190 Sant Cugat Valles, Barcelona / **Sonitec Electronica**, C.B., 815.74.44, Cl Aigua 143, 08800 Vilanova I Geltru, Barcelona / **Totvisio Electronica S.L.**, 873.88.81, Pj Ferrer 14, 08240 Manresa, Barcelona / **4 En 1 Reparaciones**, 430.97.2, Cl Taquigrafo Marti 19, 08028 Barcelona / **Movilfrit S.A.**, 93/ 630.14.53, Cl Osca 11-C Pol.Salinas, 08830 Sant Boi De Ll., Barcelona / **Tele-Servei Bruc S.L.**, 93/ 207.08.08, Cl Rossello 289, 08037 Barcelona / **Sabe Electronica**, 964/ 21.52.65, Cl Joaquin Costa 46, 12004 Castellon / **F.Carceller-F.Cervera,C.B**, 964/ 45.44.65, Cl Carrero 29, 12500 Vinaros, Castellon / **Asiste, S.L.**, 964/ 21.57.69, Av De Valencia Nave 19, 12006 Castellon / **Technotronic**, 971/ 32.27.62, Cl Ibiza 12, 07860 San Fco. Javier, Formentera / **Reparaciones Pilsa S.C.**, 972/ 20.66.96, Cl J. Pascual I Prats 8, 17004 Gerona / **Satel**, 972/ 26.55.19, Ps De Barcelona 12, 17800 Olot, Girona / **Salleras Puig Juan**, 972/ 50.67.54, Cl Pou Artesia 4, 17600 Figueres, Girona / **Riera Daviu**, 972/ 50.32.64, Cl Torras Y Bages 19, 17600 Figueres, Girona / **Lavison, C.B.**, 972/ 23.01.22, Cl Montseny 35, 17005 Girona / **Monje Ure#A Manuel**, 972/ 70.25.52, Cl Sant Quinti 33, 17534 Ribes De Freser, Girona / **Estudios 3, C.B.**, 943/ 45.37.97, Pz De Los Estudios 3, 20011 San Sebastian, Guipuzcoa / **Teknibat Electronica**, 943/ 70.24.37, Cl Zezenbide 4, 20600 Eibar, Guipuzcoa / **Reparaciones Urruti S.L.**, 943/ 45.84.10, Ps Aintzieta 32, 20014 San Sebastian, Guipuzcoa / **Teleservic**, 974/ 31.34.44, Cl Estadi 6, 22300 Barbastro, Huesca / **Servielectro**, 974/ 21.00.14, Cl Baltasar Gracian 5, 22002 Huesca / **Telesonic**, 974/ 36.32.97, Cl Teruel 6, 22700 Jaca, Huesca / **Teleservicio**, 974/ 22.01.39, Cl Tenerias 20, 22001 Huesca / **Satof**, 973/ 50.08.48, Av Raval Del Carme 12, 25300 Tarrega, Lerida / **Ielsa, C.B.**, 973/ 24.71.27, Cl Tarragona 40, 25005 Lleida / **Cristel**, 973/ 27.08.26, Cl Vallcalent 32, 25006 Lleida / **Unitec**, 948/ 82.74.34, Cl Fuente Canonigos 5, 31500 Tudela, Navarra / **Telsan, C.B.**, 948/ 24.19.50, Cl Gayarre 1 Bjos., 31005 Pamplona, Navarra / **Euro Tecnic Electronica**, 977/ 32.24.89, Cl Lepanto 16-18, 43202 Reus, Tarragona / **Electro Servei C.B.**, 977/ 51.04.42, Ps Moreira 10, 43500 Tortosa, Tarragona / **A.B.R. Electronica S.L.**, 977/ 50.21.20, Cl Calderon La Barca 3, 43520 Roquetas, Tarragona / **Curto Gamundi S.R.C.**, 977/ 44.13.14, Cl Rierol Caputxins 6, 43500 Tortosa, Tarragona / **Selecco S.L.**, 977/ 70.00.12, Cl Calderon De La Barca 11, 43870 Amposta, Tarragona / **Electronica S. Torres**, 977/ 21.21.48, Cl Joan Miro 4 Esc.D 1-2, 43005 Tarragona / **Buira Tecnic's**, 977/ 66.04.37, Cl San Javier 55, 43700 El Vendrell, Tarragona / **Tecno Serveis Mora**, 977/ 40.08.83, Cl Pau Picasso 1, 43740 Mora D'ebre, Tarragona / **Sertecs, S.C.**, 977/ 22.18.51, Cl Caputxins (Bajos) 22, 43001 Tarragona / **Electronica Josep**, 977/ 88.04.41, Ctra. Igualada 29 Bjos, 43420 Sta. Coloma Queralt, Tarragona / **Martorell Altes**, 977/ 75.32.41, Cl Roseta Mauri 10, 43205 Reus, Tarragona / **Teleservicio S.C.**, 978/ 87.08.10, Cl Romualdo Soler 4, 44600 Alcañiz, Teruel / **Electronica Alcañiz S.L.**, 979/ 87.07.94, Cl Carmen 21, 44600 Alcañiz, Teruel / **Sonovision**, C.B., 978/ 60.11.74, Cl Abadia 5, 44001 Teruel / **Electronica Moncho**, 96/287.23.29, Cl Pare Pascual Cat. 5, 46700 Gandia, Valencia / **Envisa Electronic, S.L.**, 96/241.24.87, Cl General Espartero 9, 46600 Alzira, Valencia / **Antonio Monleon, S.L.**, 96/334.55.87, Av De La Plata 91, 46006 Valencia / **Tecno Hogar**, 96/286.53.35, Cl Dos De Mayo 41, 46700 Gandia, Valencia / **Servicios Electronicos**, 96/340.20.34, Cl Doctor Oloriz 3, 46009 Valencia / **Electronica Las Heras**, 96/ 238.11.14, Cl Jose Iranzo 6, 46870 Ontinyent, Valencia / **Negredo Martin Daniel**, 94/411.22.82, Cl Padre Pernet 8, 48004 Bilbao, Vizcaya / **Collantes Martin Onofre**, 94/ 483.21.22, Cl Ortuño De Alango 7, 48920 Portugalete, Vizcaya / **Argi Giltz**, 94/ 443.77.93, Cl Autonomia 15, 48012 Bilbao, Vizcaya / **Servitele**, 94/444.89.02, Cl Autonomia 24 Galerias, 48012 Bilbao, Vizcaya / **Cinca Monverde Antonio**, 976/ 31.69.65, Cl Via Universitat 52, 50010 Zaragoza / **Aragon Televideo, S.C.**, 976/ 32.97.12, Cl Batalla Clavijo 18, 50010 Zaragoza / **Tv Video Jimenez, S.L.**, 967/ 34.04.43, Cl Juan Xxiii 38, 02640 Almansa, Albacete / **Juman**, 967/ 22.40.78, Cl Ejercito 1, 02002 Albacete / **Televideo**, 950/ 40.18.63, Cl Velazquez 7 Local-A, 04770 Adra, Almeria / **Servicio Tecnico Ponce**, 950/ 45.67.53, Ub Monte Almagro 10, 04610 Cuevas De Almanzora, Almeria / **Sonivitel S.L.**, 950/ 22.97.55, Cl Poeta Paco Aquino 51, 04005 Almeria / **Electronica Edimar**, S.A, 98/535.34.51, Cl Cangas De Onis 4, 33207 Gijon, Asturias / **Cañedo S.T.**, 98/522.29.68, Cl Otero, S/N C. Cial, 33008 Oviedo, Asturias / **Alvarez Olivar Casilda**, 98/522.37.39, Cl San Jose 12, 33003 Oviedo, Asturias / **Santiago Valderrey**, 98/ 563.18.61, Cl Dr. Venancio Mtez. 7, 33710 Navia, Asturias / **Astusetel S.L.**, 98/539.10.11, Cl Cea Bermudez 9, 33208 Gijon, Asturias / **Asturservice**, 98/556.83.87, Cl Sanchez Calvo 6 Bjos., 33401 Aviles, Asturias / **Juan Morillon Del Corro**, 98/567.40.24, Av De Gijon 19, 33930 La Felguera/Langreo, Asturias / **S.A.T. Juan-Manuel**, 98/ 581.22.48, Cl Uria 60, 33800 Cangas De Narcea, Asturias / **Daniel Serrano Labrado**, 920/ 37.15.16, Cl Jose Gochicoa 16, 05400 Arenas De S.Pedro, Avila / **Electronica Gredos**, 920/ 22.48.39, Cl Eduardo Marquina 24, 05001 Avila / **Jimenez Almohalla**, 920/ 25.08.76, Cl Jacinto Benavente 1, 05001 Avila / **Electronica Bote**, 924/ 22.17.40, Pz Portugal 2, 06001 Badajoz / **Marcial Lagoa Gonzalez**, 924/ 49.03.33, Cl Ramon Y Cajal 7, 06100 Olivenza, Badajoz / **C.E. Vilanovense C.B.**, 924/ 84.59.92, Cl Camino Magacela 4 Local-5, 06700 Villanueva Serena, Badajoz / **Electronica Centeno S.L.**, 924/ 57.53.08, Av Del Zafra 1, 06310 Puebla Sancho Perez, Badajoz / **Indalecio Amaya Sanchez**, 924/ 66.47.01, Cl Carreras 11, 06200 Almendralejo, Badajoz / **Patricio Electronica**, 924/ 33.04.13, Cl Reyes Huertas 7, 06800 Merida, Badajoz / **Electronica Mas**, 947/ 31.49.94, Cl Alfonso Vi 6, 09200 Miranda De Ebro, Burgos / **Servitec Burgos S.L.**, 947/ 22.41.68, Cl Lavaderos 7-9, 09007 Burgos, Burgos / **Ruiz Garcia Jose**, 927/ 22.48.86, Cl Ecuador 5-B, 10005 Caceres / **Arsenio Sanchez**, C.B., 927/ 41.11.21, Cl Tornavacas 9, 10600 Plasencia, Caceres / **Zabala Vazquez Jose**, 927/ 57.06.13, Cl Del Agua 39, 10460 Losar De La Vera, Caceres / **Radio Sanchez C.B.**, 927/ 32.06.88, Av De Miajadas S/N, 10200 Trujillo, Caceres / **Electronica Jeda**, Cl Pagador 31, 11500 Pto. Sta. Maria, Cadiz / **Servicio Tecnico**, 956/ 87.07.05, Cl Divina Pastora E-1 L-4, 11402 Jerez La Frontera, Cadiz / **Jose Borja Y Jose Arana**, 956/ 66.60.53, Cl San Antonio 31, 11201 Algeciras, Cadiz / **Vhifitel**, 956/ 46.25.01, Cl Fco.Fdez.Ordo|Ez 5, 11600 Ubrique, Cadiz / **Galan Sat S.L.**, 956/ 20.14.17, Cl Cruz Roja Española 11, 11009 Cadiz / **Galan Sat S.L.**, 956/ 83.35.35, Cl Factoria Matagorda 52, 11500 Puerto Real, Cadiz / **Electronica Seyma**, 942/ 23.69.19, Cl Del Monte 69 C Bjos, 39006 Santander, Cantabria / **Tele-Nueva**, 926/ 50.59.96, Cl Campo 56, 13700 Tomelloso, Ciudad Real / **Electronica Arellano**, 926/ 54.78.95, Cl Lorenzo Rivas 14, 13600 Alcazar De San Juan, Ciudad Real / **Electronica Lara**, 926/ 21.17.87, Cl De La Jara 1, 13002 Ciudad Real / **Manuel Vazquez**, 926/ 42.09.93, Cl Aduana 3, 13500 Puertollano, Ciudad Real / **Electrodiaz S.L.**, 926/ 32.23.24, Cl Buensuceso 10, 13300 Valdepe|As, Ciudad Real / **Due|As Ca|As Teodoro**, 957/ 26.35.06, Cl Hermano Juan Fdez 15, 14014 Cordoba / **Electronica Sales**, 957/ 66.09.04, Cl Andalucia 11, 14920 Aguilar Frontera, Cordoba / **Lavison Electronica S.L.**, 957/ 75.01.75, Cm De La Barca 3, 14010 Cordoba / **Antonio Gonzalez**, 957/ 57.10.50, Cl Gral Primo Rivera 61, 14200 Peñarroya, Cordoba / **Electronica Garcia**, 969/ 22.24.83, Cl Ramon Y Cajal 17, 16004 Cuenca / **Gallardo Alonso Miguel**, 958/ 67.64.81, Cl Carmen 104, 18510 Benalua De Guadix, Granada / **Vilchez Vilchez Rafael**, 958/ 60.06.50, Cl Amadeo Vives 9, 18600 Motril, Granada / **Electronica Wenceslao**, 958/ 81.16.16, Cl Fontiveros 42, 18008 Granada, Granada / **Digmat Electronica**, 958/ 70-04-52, Cl Casicas 7, 18800 Boza, Granada / **Megatecnica Extremeira**, 958/ 26.06.01, C./Mozart L-2 Ed.Granate, 18004 Granada, Granada / **Tecnicas Marvi S.L.**, 949/ 23.27.63, Pz Capitan Boixareu 51, 19001 Guadalajara / **Abril Sanchez Valentin**, 959/ 10.60.41, Cl Cadiz 2, 21270 Cala, Huelva / **Telesonid Huelva, S.C.A.**, 959/ 24.38.60, Cl Fco.Vazquez Limon 4, 21002 Huelva / **Electronica Sur**, 959/ 47.11.51, Cl M. Lerdo De Tejada 9, 21400 Ayamonte, Huelva / **Electro Himega, S.A.**, 953/ 24.22.56, Cl Adarves Bajos 4-C, 23001 Jaen / **Electronica Jumar**, 953/ 26.17.08, Cl Goya (Las Flores) 1, 23006 Jaen / **Electronica Gonzalez**,

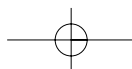

· SERVICE NIEDERLASSUNGEN · ADDRESSES D'ENTRETIEN · ONDERHOUDSADRESSEN · DIRECCIONES DE SERVICIO · INDIRIZZI DI SERVIZIO ·

953/ 50.33.82, Corredera San Bartolome 11, 23740 Andujar, Jaen / **Uniservic Electronica**, 953/ 75.14.19, Cl Goya 1 Bjos, 23400 Ubeda, Jaen/ **Anuma**, 953/ 69.70.41, Cl Paredon 24, 23700 Linares, Jaen / **Talleres Instaluz**, 981/ 26.80.26, Cl Juan Florez 110, 15005 La Coruña / **Garcia Quintela Arturo**, 981/ 70.21.07, Cl Xoane, 15100 Carballo, La Coruña / **Manuel Mato Señaris**, 981/ 53.71.14, Cl Silvouta-Pedra Da, 15896 Santiago Compostela, La Coruña / **Zener Electronica**, 981/ 22.07.00, Cl Ronda De Monte Alto 15, 15002 La Coruña / **S.T. Mendez**, 981/ 27.52.52, Cl Gil Vicente 13, 15011 La Coruña / **Electronica Castilla**, 981/ 32.14.09, Cr Castilla 377-Bis Bjos, 15404 Ferrol, La Coruña / **Bandin Audio**, 981/ 86.60.23, Cl Rua Arcos Moldes 2 B-3, 15920 Rianxo, La Coruña / **Electronica Torres, S.C.**, 941/ 24.76.15, Av Navarra 14, 26001 Logro#O, La Rioja / **Top Service**, 941/ 13.50.35, Cl Achutegui De Blas 17, 26500 Calahorra, La Rioja / **Aguado Gil Roberto**, 941/ 25.25.53, Av Viana 10, 26001 Logro#O, La Rioja / **Telson**, 987/ 21.25.18, Cl Batalla Clavijo 2, 24006 Leon / **Salvador Rodriguez, C.B.**, 987/ 40.36.02, Cl Ortega Y Gasset 24, 24400 Ponferrada, Leon / **Prosat**, 987/ 20.34.10, Pz Doce Martires 5, 24004 Leon / **Electronica Fouces**, 982/ 40.24.38, Cl Benito Vicetto 34, 27400 Monforte De Lemos, Lugo / **Televexo S.L.**, 982/58.18.57, Cl Nasa Sra. Do Carmen 82, 27880 Burela, Lugo / **Electronica Penelo**, 982/ 21.47.43, Cl Serra Ga#ldoira 63, 27004 Lugo / **Gomescan**, 91/305.48.90, Pz Del Jubilado 8, 28042 Barajas-Madrid, Madrid / **Electronica Garman, C.B.**, 91/368.01.79, Cl Mandarina 15, 28027 Madrid / **Electronica Ansar**, 91/ 460.47.45, Cl Tomasa Ruiz 4, 28019 Madrid / **Tec-Norte**, 91/851.63.47, Cl Santiago Apostol 12, 28400 Collado Villalba, Madrid / **Variosat, S.L.**, 91/662.04.68, Cl Isla De Corcega 24, 28100 Alcobendas, Madrid / **Elbeservi, S.A.**, 91/386.27.11, Cl Dr.R. Castroviejo 19, 28029 Madrid / **Alcala Servitec C.B.**, 91/889.00.32, Cl Santa Ursula 5, 28801 Alcala De Henares, Madrid / **Garman C.B.**, Cl Carlos Sole 38 Local, 28038 Madrid / **Aviles Sanchez Antonio**, 952/ 36.16.02, Cl Ciudad De Andujar 2, 29006 Malaga / **Video Taller, S.C.**, 952/ 54.23.95, Edif. La Noria B Bjos-5, 29740 Torre Del Mar, Malaga / **Servisuel, Edif. La Union**, 952/ 46.90.28, Cm De Las Ca#Adas Lc 2, 29640 Fuengirola, Malaga / **Biser, S.L.**, 952/ 25.55.53, Cl Lozano De Torres 8, 29013 Malaga / **Electro Ronda**, 952/ 87.59.99, Cl Santa Cecilia 11, 29400 Ronda, Malaga / **Diego Lopez Jodar**, 95/ 280.12.23, Pz Del Reloj 13, 29680 Estepona, Malaga / **Caro Porlan Raimundo**, 968/ 46.18.11, Cl Jose Mouliac 45, 30800 Lorca, Murcia / **Reg., C.B.**, 968/ 51.00.06, Cl Antonio Oliver 17, 30204 Cartagena, Murcia / **Electroservicios Seba, C.B.**, 968/ 29.85.93, Cl Isaac Albeniz 4 Bjos, 30009 Murcia / **Visatel**, 968/24.16.47, Cl Torre Alvarez S/N, 30007 Murcia / **Electro Servicios Plaza**, 968/ 28.45.67, Cl Gomez Cortina 10, 30005 Murcia / **Rafael Gomez Yelo**, 968/ 26.14.67, Ps Corbera 17, 30002 Murcia / **Fernandez Gonzalez Jose**, 988/ 23.48.53, Av Buenos Aires 75 Bjos, 32004 Orense / **Electronica Javier**, 979/ 75.03.74, Cl Ramirez 5, 34005 Palencia / **Central De Servicios**, 986/ 37.47.45, Cl Asturias (Bajo) 10, 36206 Vigo, Pontevedra / **Montajes Servicios Tecn.**, 986/ 84.16.36, Cl Loureiro Crespo 43, 36004 Pontevedra / **Sial-Alvimo S.L.**, 986/ 29.93.01, C/ C.Torrecedeira 92 Bjos, 36202 Vigo, Pontevedra / **Electronica Cambados**, 986/ 50.83.27, Cl Camilo Jose Cela 13, 36600 Vilagarcia Arousa, Pontevedra / **Almat Electronica**, 923/ 22.45.08, Cl Galileo 21, 37004 Salamanca / **Guijo S.T.**, 921/ 42.94.18, Cl Ramon Y Cajal 1, 40002 Segovia / **AvitelSAT, S.A.**, 954/ 66.21.52, Cl Espinosa Y Carcel 31, 41005 Sevilla / **Vanhcolor, S.L.**, 95/433.83.03, Cl San Jacinto 96, 41010 Sevilla / **Telepal**, 95/464.95.80, Cl Julio Verne 49, 41006 Sevilla / **Auvitel, S.L.**, 95/427.57.07, Cl Virgen De Africa 20, 41011 Sevilla / **Audio Color**, 95/457.94.47, Cl Golgota 3 LocalHзда., 41003 Sevilla / **Electro 93 S.L.**, 95/ 472.37.16, Cl Melliza 1, 41700 Dos Hermanas, Sevilla / **Teco**, 975/ 22.61.25, Cl Antolin De Soria 10, 42003 Soria / **Electronica Rivas**, 925/ 80.55.46, Cl Barrio San Juan 1, 45600 Talavera La Reina, Toledo / **Electronica Fe-Car, S.L.**, 925/ 21.21.45, Av Santa Barbara 30, 45006 Toledo / **Electronica Jopal S.L.**, 925/ 25.04.42, Av Santa Barbara S/N, 45006 Toledo / **Electro Anaya**, 925/ 48.09.81, Cl Vertedera Alta 14, 45700 Consuegra, Toledo / **Teleservicios**, 983/ 30.92.61, Cl Esgueva 6, 47003 Valladolid / **Asist. Tecnica Marcos**, 983/ 29.78.66, Cl Pio Del Rio Hortega 2-4, 47014 Valladolid / **Electronica Vitelson**, 983/ 80.43.56, Pz Del Mercado 9, 47400 Medina Del Campo, Valladolid / **R.T.V. Blanco**, 980/ 51.14.41, Cl Eduardo Julian Perez 9, 49018 Zamora

SWITZERLAND

Sharp Electronics AG, Langwiesenstrasse 7, 8108 Dällikon, Tel: +41 1 846 61 11.

SWEDEN

Vid förfrågningar angående din mikrovågsugn var vänlig kontakta din återförsäljare eller någon av Sharps representanter
Centralservice Umeå, Formvägen 8, 90621 Umeå, Phone: 090-125001, Fax: 090-131135 / **MN Elektronikservice AB**, Flygplatsinfarten 10A, 161 11 Bromma, Phone: 08-6275900, Fax:08-6275160 / **Jönköpings Antenn & TV Service**, Fridhemsvägen 20, 553 02 Jönköping, Phone: 036-161690, Fax: 036-160211 / **Ratronik Radio & TV Service**, Nordlandergatan 15, 931 32 Skellefteå, Phone: 0910-17305, Fax: 0910-16844 / **Tomi Elektronik AB**, Bäckvägen 90, 126 47 Hägersten, Phone: 08-186170, Fax: 08-186175 / **Tretronik**, Östermovägen 33, 854 62 Sundsvall, Phone: 060-155925, Fax: 060-173690 / **TV-Trim Service AB**, S:T Pauligatan 37, 416 60 Göteborg, Phone: 031-847200, Fax: 031-847500

NORWAY

Finn Clausen AS, Postbox 274, No-0511 Oslo, Phone: 47-22635000, Fax: 47-22646655
Norsk Elektronik senter, Postbox 13, No-2007 Kjeller, Phone: +47-63804500, Fax: +47-63804501

ICELAND

Braedurnir Ormsson Ltd, PO box 8790, IS-128 Reykjavik, Phone: +354-5332800, Fax: +354-5332810
Hjoltmaekni Ehf, Skeifar, IS-108 Reykjavik, Phone: +354-5332150, Fax: +354-5332151

DENMARK

Sö Höyem AS, Büllowsvej 3, DK-1870 Fredriksberg C, Phone: 45-31224434, Fax: 45-31224127
Almstock Radio & Tv service, Sallingsvej 61, DK-2720 Vanløse, Phone: 45-38740021, Fax:45-38740031

SUOMI

Oy Perkko, PL 40 Rällsintie 6, SF-00721 Helsinki, Phone: +35-8947805000, Fax: +35-8947805480
Theho Video, Kuotaankatu 7, SF-00520 Helsinki, Phone: +35-891451500, Fax: +35-891461767



SPECIFICATIONS

AC Line Voltage		: 230 V, 50 Hz, single phase
Distribution line fuse/circuit breaker		: Minimum 10 A
AC Power required:	Microwave	: 1.25 kW
	Grill	: 1.05 kW
Output power:	Microwave	: 800 W (IEC 60705)
	Grill	: 1000 W
Microwave Frequency		: 2450 MHz
Outside Dimensions		: 449 mm(W) x 282 mm(H) x 372 mm(D)
Cavity Dimensions		: 290 mm(W) x 194 mm(H) x 313 mm(D)
Oven Capacity		: 18 litres
Turntable		: \varnothing 272 mm
Weight		: Approx. 14 kg
Oven lamp		: 25 W/240 - 250 V



This equipment complies with the requirements of directives 89/336/EEC and 73/23/EEC as amended by 93/68/EEC.

As part of a policy of continuous improvement, we reserve the right to alter design and specifications without notice

SHARP

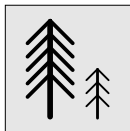

*Der Zellstoff zur
Herstellung dieses
Papiers kommt zu
100 % aus nachhaltig
bewirtschafteten
Wäldern*

*Ce papier est
entièrement fabriqué
à partir de pâte à
papier provenant
de forêts durables*

*De pulp die gebruik is
voor de vervaardiging
van dit papier is voor
100 % afkomstig uit
bossen die doorlopend
opnieuw aangepland
worden*

*Il 100 % della pasta
utilizzata per
produrre questa carta
proviene da foreste
sostenibili*

*El 100 % de la
pasta utilizada en
la fabricación de
este papel procede
de bosques
sostenibles*

*Este papel é
totalmente fabricado
a partir de pasta de
papel proveniente
de florestas duráveis*

SHARP ELECTRONICS (EUROPE) GMBH.
Sonninstrasse 3, 20097 Hamburg
Germany

TINS-A297URRO

Gedruckt in Grossbritannien
Imprimé au Royaume-Uni
Gedruckt in Groot-Brittannie
Stampato in Gran Bretagna
Impreso en el Reino Unido
Impresso no Reino Unido

SHARP



*Das Papier dieser
Bedienungsanleitung
besteht zu 100 %
aus Altpapier*

*Le papier de ce
mode d'emploi est
fait de 100 %
de papier réutilisé*

*De papier voor deze
gebruiksaanwijzing
is van 100 %
hergebruiken papier
gemaakt*

*La carta di questo
manuale d'istruzioni
è fatta di 100 %
della carta riciclata*

*El papel de este
manual de
instrucciones se
hace de 100 %
es del papel
reciclado*

*O papel deste
manual da operação
é feito de 100 %
do papel recycled*

SHARP ELECTRONICS (EUROPE) GMBH.
Sonninstrasse 3, 20097 Hamburg
Germany

TINS-A297URRO

Gedruckt in Grossbritannien
Imprimé au Royaume-Uni
Gedruckt in Groot-Brittannie
Stampato in Gran Bretagna
Impreso en el Reino Unido
Impresso no Reino Unido